



SP-3U/6U Series Wide-range High-power Programmable DC Power Supply & System

- High Efficiency
- High Precision
- High Stability

SP-3U/6U Series Wide-range High-power Programmable DC Power Supply

SP-3U/6U Series Wide-range High-power Programmable DC Power Supply



(3U)6000W~18000W



(6U)24000W~36000W

Output			Model	Size	Ripple		Response		Internal Resistance
Rated Voltage	Rated Current	Rated Power			Voltage	Current	Voltage increase	Voltage Drop	
80V	200A	6000W	SP80VDC6000W	3U ①	<180mVpp, <15mVrms	<100mArms	<15ms (No Load) <30ms (Full Load)	<850ms (No Load) <15ms (Full Load)	0~12Ω
	400A	12000W	SP80VDC12000W	3U ②	<288mVpp, <23mVrms	<200mArms			0~6Ω
	600A	18000W	SP80VDC18000W	3U ③	<320mVpp, <25mVrms	<300mArms			0~4Ω
	800A	24000W	SP80VDC24000W	6U ④	<320mVpp, <25mVrms	<360mArms			0~3.0Ω
	1000A	30000W	SP80VDC30000W	6U ⑤	<320mVpp, <25mVrms	<450mArms			0~2.4Ω
	1200A	36000W	SP80VDC36000W	6U ⑥	<320mVpp, <25mVrms	<540mArms			0~2.0Ω
165V	180A	12000W	SP165VDC12000W	3U ②	<540mVpp, <50mVrms	<100mArms	<15ms (No Load) <30ms (Full Load)	<900ms (No Load) <15ms (Full Load)	0~27.5Ω
	360A	24000W	SP165VDC24000W	6U ④	<540mVpp, <50mVrms	<200mArms			0~13.75Ω
	540A	36000W	SP165VDC36000W	6U ⑥	<540mVpp, <50mVrms	<300mArms			0~9.167Ω
250V	180A	18000W	SP250VDC18000W	3U ③	<550mVpp, <50mVrms	<100mArms	<15ms (No Load) <30ms (Full Load)	<950ms (No Load) <15ms (Full Load)	0~41.6667Ω
360V	42.5A	6000W	SP360VDC6000W	3U ①	<320mVpp, <55mVrms	<21mArms	<15ms (No Load) <80ms (Full Load)	<800ms (No Load) <15ms (Full Load)	0~440Ω
	85A	12000W	SP360VDC12000W	3U ②	<320mVpp, <55mVrms	<43mArms			0~220Ω
	127.5A	18000W	SP360VDC18000W	3U ③	<320mVpp, <55mVrms	<64mArms			0~147Ω
	170A	24000W	SP360VDC24000W	6U ④	<350mVpp, <60mVrms	<85mArms			0~64Ω
	212.5A	30000W	SP360VDC30000W	6U ⑤	<350mVpp, <60mVrms	<106mArms			0~51Ω
	255A	36000W	SP360VDC36000W	6U ⑥	<350mVpp, <60mVrms	<128mArms			0~43Ω
500V	32A	6000W	SP500VDC6000W	3U ①	<600mVpp, <150mVrms	<16mArms	<15ms (No Load) <80ms (Full Load)	<1500ms (No Load) <15ms (Full Load)	0~469Ω
	64A	12000W	SP500VDC12000W	3U ②	<650mVpp, <160mVrms	<32mArms			0~235Ω
	96A	18000W	SP500VDC18000W	3U ③	<650mVpp, <160mVrms	<48mArms			0~157Ω
	128A	24000W	SP500VDC24000W	6U ④	<650mVpp, <160mVrms	<64mArms			0~118Ω
	160A	30000W	SP500VDC30000W	6U ⑤	<650mVpp, <160mVrms	<80mArms			0~94Ω
	192A	36000W	SP500VDC36000W	6U ⑥	<650mVpp, <160mVrms	<96mArms			0~79Ω
750V	21A	6000W	SP750VDC6000W	3U ①	<900mVpp, <225mVrms	<11mArms	<15ms (No Load) <80ms (Full Load)	<600ms (No Load) <20ms (Full Load)	0~1072Ω
	42A	12000W	SP750VDC12000W	3U ②	<1000mVpp, <250mVrms	<22mArms			0~536Ω
	63A	18000W	SP750VDC18000W	3U ③	<1000mVpp, <250mVrms	<33mArms			0~358Ω
	84A	24000W	SP750VDC24000W	6U ④	<1000mVpp, <250mVrms	<44mArms			0~268Ω
	105A	30000W	SP750VDC30000W	6U ⑤	<1000mVpp, <250mVrms	<55mArms			0~215Ω
	126A	36000W	SP750VDC36000W	6U ⑥	<1000mVpp, <250mVrms	<66mArms			0~179Ω
1000V	32A	12000W	SP1000VDC12000W	3U ②	<1500mVpp, <320mVrms	<22mArms	<15ms (No Load) <85ms (Full Load)	<1700ms (No Load) <15ms (Full Load)	0~937.5Ω
	64A	24000W	SP1000VDC24000W	6U ④	<1500mVpp, <320mVrms	<26mArms	<15ms (No Load) <80ms (Full Load)	0~468.75Ω	
	96A	36000W	SP1000VDC36000W	6U ⑥	<1500mVpp, <320mVrms	<48mArms	0~312.5Ω		
1500V	21A	12000W	SP1500VDC12000W	3U ②	<2500mVpp, <600mVrms	<11mArms	<15ms (No Load) <80ms (Full Load)	<700ms (No Load) <20ms (Full Load)	0~2142Ω
	32A	18000W	SP1500VDC18000W	3U ③	<1950mVpp, <650mVrms	<22mArms	<15ms (No Load) <90ms (Full Load)	<1800ms (No Load) <15ms (Full Load)	0~1406.25Ω
	42A	24000W	SP1500VDC24000W	6U ④	<2500mVpp, <600mVrms	<22mArms	<15ms (No Load) <80ms (Full Load)	<700ms (No Load) <20ms (Full Load)	0~1071Ω
	63A	36000W	SP1500VDC36000W	6U ⑥	<2500mVpp, <600mVrms	<33mArms	<15ms (No Load) <80ms (Full Load)	<700ms (No Load) <20ms (Full Load)	0~714Ω
2250V	21A	18000W	SP2250VDC18000W	3U ③	<3200mVpp, <750mVrms	<11mArms	<15ms (No Load) <85ms (Full Load)	<800ms (No Load) <20ms (Full Load)	0~3214Ω

Dimensions & Weight



① 423.0x133.0x718.0 mm & 27kg



② 423.0x133.0x718.0 mm & 38kg



③ 423.0x133.0x718.0mm & 50kg



④ 423.0x265.0x745.0 mm & 75kg



⑤ 423.0x265.0x745.0 mm & 86kg



⑥ 423.0x265.0x745.0 mm & 97kg

Optional Information

- (1) US standard, input voltage range: 187~305Vac*
- (3) Continuous source & sink function*
- (5) CAN communication card

- (2) European standard, input voltage range: 340~480Vac*
- (4) GPIB & LAN communication card & cables
- (6) TTL/Analog control card

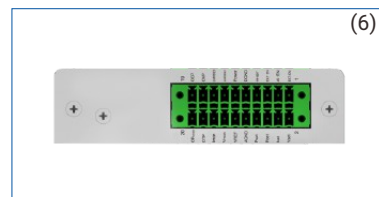
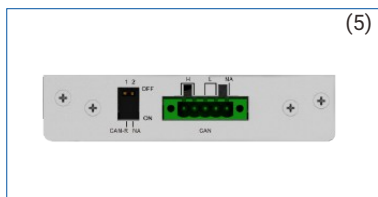

* These options must be specified at the time of order as they are installed at the factory prior to shipment.

Features

- Large color touch screen with intuitive interface provides an excellent intuition operational experience.
- 3-phase input voltage meets worldwide power distribution regulation, AC mains 187~305Vac/340~480Vac for optional.
- Constant voltage (CV), constant current (CC) and constant power (CP) operation mode, CC or CV working priority setting.
- Adjustable voltage/current slew rate.
- DDS arbitrary function generator.*
- Solar panel I-V curve simulation function.*
- Smart 3-stage charging algorithm simulation.*
- Battery simulator function.*
- Continuous source & sink function, with APM DC E-load to expand loading capability (optional).
- List/ Step mode programming.
- TTL/Analog control and monitoring.
- Built-in standard automotive power network voltage curves.*
- Full protection: OVP, OCP, OPP and OTP protection.
- Supports master-slave mode, paralleling up to 16 units.
- Supports SCPI commands, provides web GUI function.

*Only professional version units support these functions.

Supported Functions Professional Version Only

No.	Description	Application
1	DDS arbitrary function generator	Includes a true function generator, built-in typical functions, supports complex waveforms creation, used for testing purposes in development and production
2	Solar panel I-V curve simulation function	Users can set the parameters to simulate I-V curve characteristic output
3	Smart 3-stage charging algorithm simulation	Commonly used charging curve simulation
4	Battery simulator function	Truly simulate the changes of internal resistance of battery in charging and discharging test.
5	Built-in standard automotive power network voltage curves	Users can recall the built-in standard curve to do the DUT performance test directly.

Panel Introduction

Front Panel Description

- ① Power switch
- ② Color touch screen
- ③ Selection soft keys
- ④ Voltage/Current & Power knob
- ⑤ Numeric and functional keys
- ⑥ USB port, for data transfers and firmware upgrading
- ⑦ Stylus

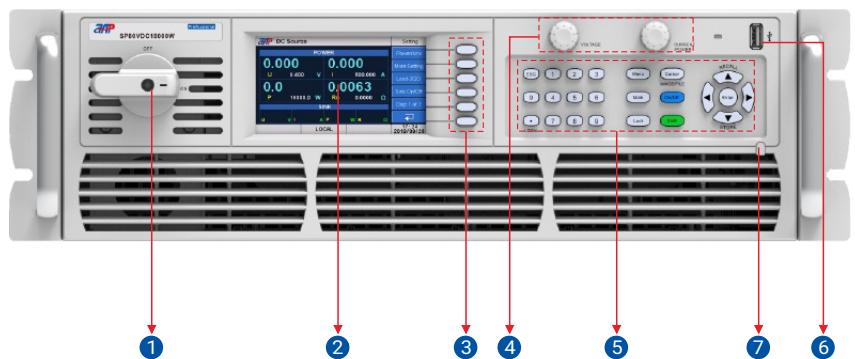

Rear Panel Description

- ① RS485/RS232/USB communication interface (standard), LAN&GPIB communication interface (optional), CAN communication interface (optional)*
- ② External TTL/Analog control interface.
- ③ System Bus, for master/slave system data transmission
- ④ Termination resistor CAN-R
- ⑤ DC output negative/positive terminal
- ⑥ AC mains input connector

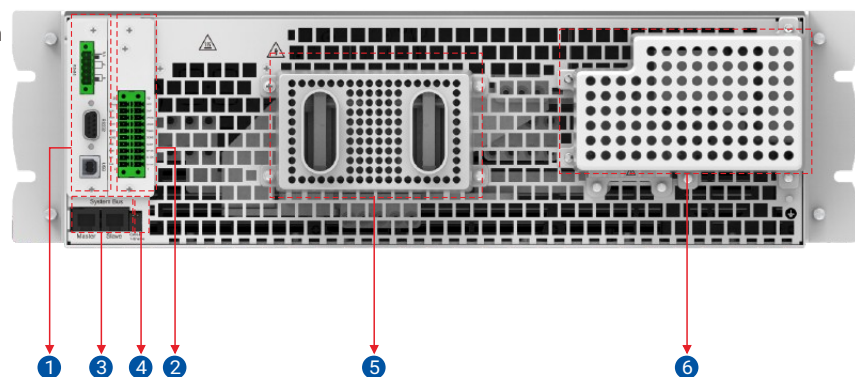

* These interface option installs in place of the standard RS485/RS232/USB interfaces, occupies the same physical slot.

Function Introduction

Graphical User Interface

The large color touch screen provides simple and fast operation for customers, real-time update of display output data and power status. The actual values are displayed with bigger characters, so they can be read from a large distance.



Wide Input Voltage Range & High Power Density

3-phase input voltage range 187~480Vac meets worldwide power distribution regulation. 36kW/6U high density, higher efficiency, lower ripple and fast response make it ideal for test requirements in different periods of different applications. This series power supply can have from one to three internal 6kW power blocks, each of which is connected across a separate phase of the 3-phase AC mains. The following figures illustrate how to install three 6kW units or three 12kW to obtain a balanced current draw on the 3-phase AC mains.

Phase balancing connection for three 6kW units

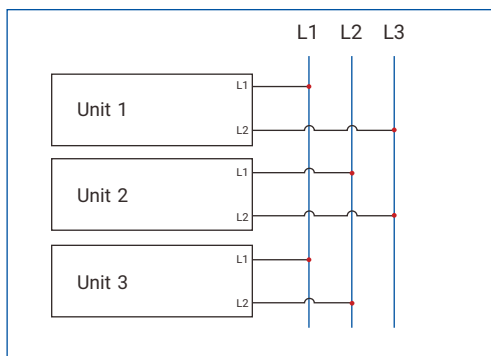

Phase balancing connection for three 12kW units

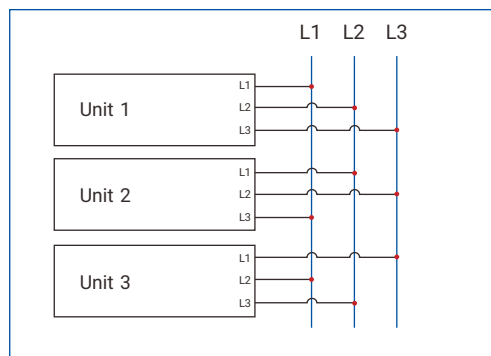

CC & CV Priority

This series power supply provides CC/CV priority function allows the user to select suitable mode correspond to test requirement, let the output be voltage high speed or current no overshoot mode. Below shows an application of CC priority to avoid current overshoot during LED test.

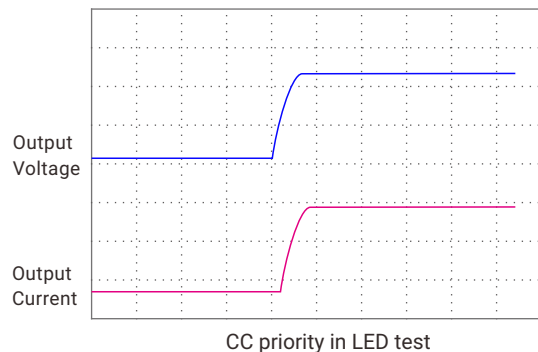
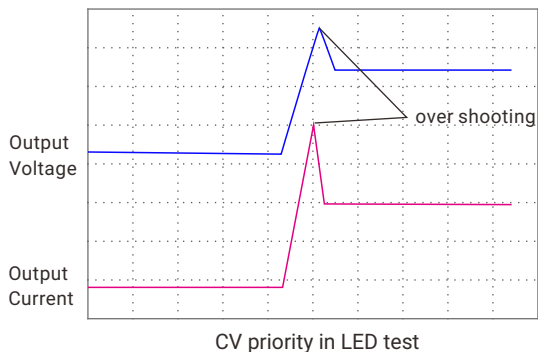

Adjustable Voltage/Current Slew Rate

This series power supply provides adjustable rise and fall slew rate setting for voltage and current.

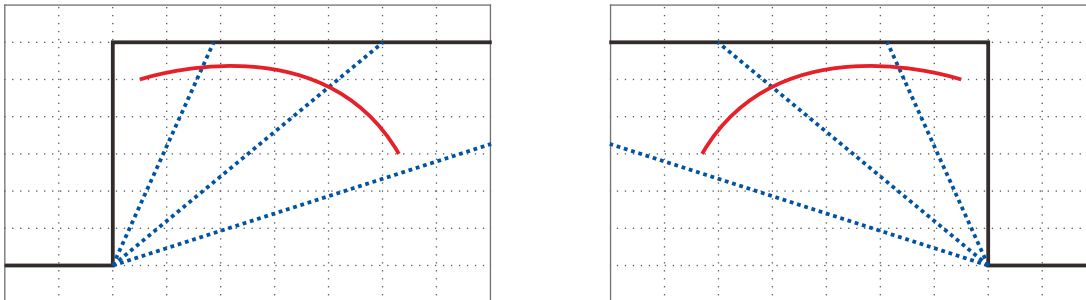

* Actual ramp down time may shift refer to load.

DDS Arbitrary Function Generator

This series power supply includes a true function generator which can generate typical functions as displayed below, convenient for editing or directly recall. Additional to the standard functions, this arbitrary generator is accessible for the creation and execution of complex sets of functions, which is can be used for testing purposes in development and production.

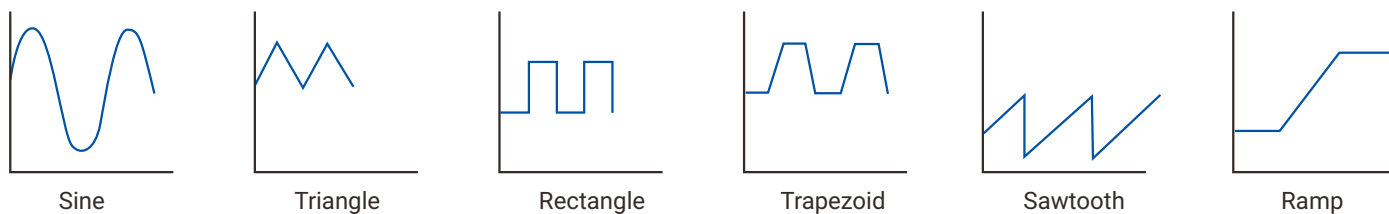

Built-in Standard Automotive Power Network Voltage Curves

This series power supply has built-in German DIN40839 standard voltage curve for the automotive power network and the international standard ISO-16750-2 pulse waveform. The fast rise/fall response time together with arbitrary function generate ability make it can truly simulate the influence on the performance of automotive electronic equipment under different test conditions, is the preferred power testing instrument in the automotive electronics industry.

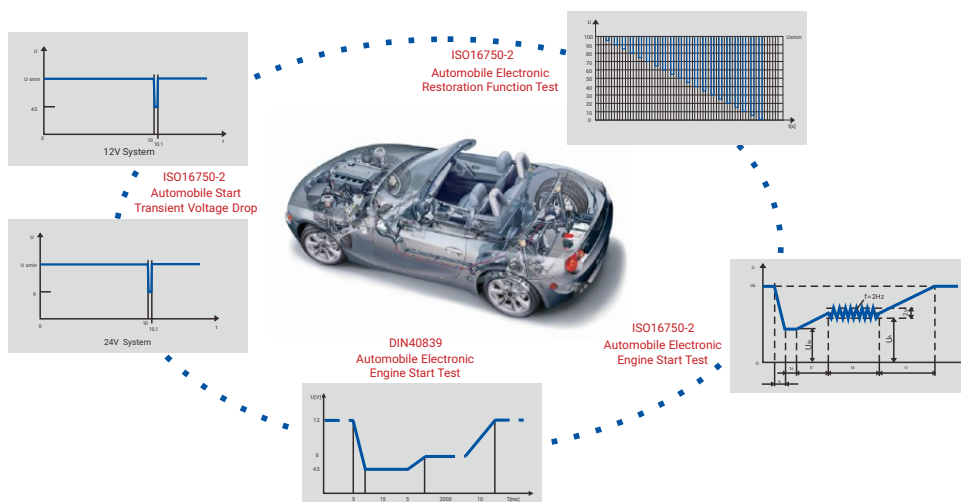

Solar Panel I-V Curve Simulation Function

The power supply provides a unique feature to simulate the output characteristics of a solar array including Curve Mode, User-defined Mode and SAS Mode. With Curve mode, only need to set four parameters to simulate the solar array I-V curve. With User-defined mode, user can shape an I-V curve by entering up to 4096 points to simulate dynamic cloud cover effect which is useful for MPPT performance evaluation on PV inverter device. With built-in SAS mode, user can set the parameters to simulate I-V curve characteristic output and generate reports.

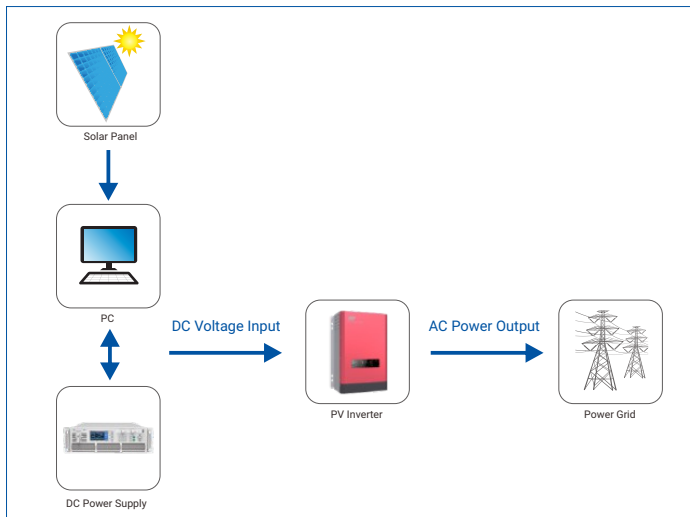
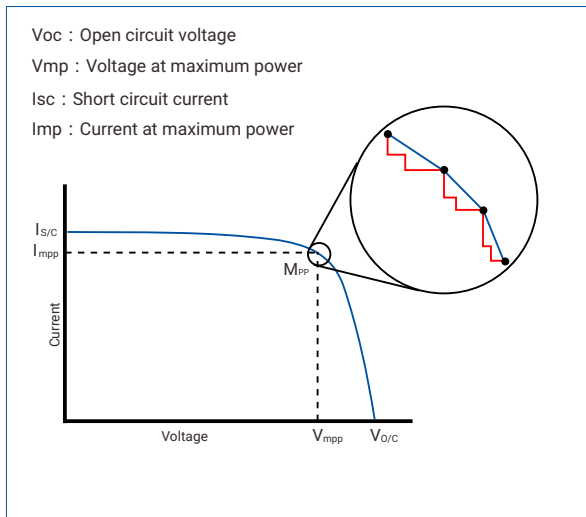

Continuous Source & Sink Function (optional)

Additionally to the Source mode, this series power supply is equipped with electronic load, also called Sink mode, to absorb power, that enables it work as a two-quadrant power supply. The switchover between these two operating modes occurs without interruption and time loss, thus avoiding overshoot of voltage or current. As a power supply, CV, CC, CP modes are available. As an electronic load, CV, CC, CP and CR mode are available. Thus making it suitable for inductive load and capacitive load testing.

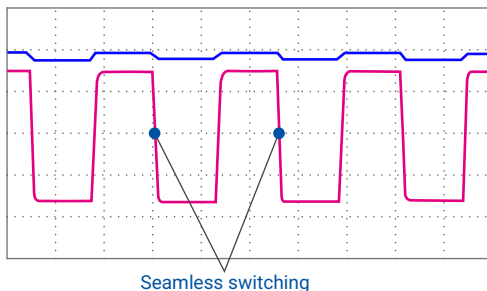

With APM DC E-load To Expand Loading Capability

If a large fast current sinking capability is required, the user can choose APM programmable electric DC loads as well. A power supply can connect and control three DC loads at the same time through CAN communication to realize a rapid response system. Meeting demanding requirements of high power discharging test.

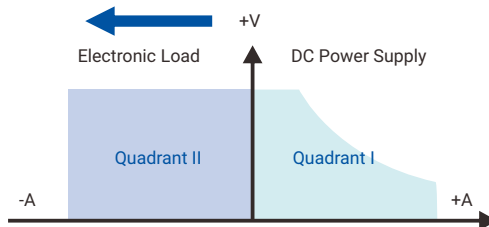

Smart 3-stage Charging Algorithm Simulation

This series power supply adopts 3-stage charging algorithm, built-in charging curves which is suitable for the commonly known types of batteries on the market. Users can directly recall the default curves or change the switching conditions at different charging stage according to the test requirement. Through the internal design, it improved and optimized hardware improvements, the current passing from the battery to power supply will be less than 10mA at any battery voltage when turn off the power supply. Thus avoid battery capacity loss, even when there is no anti reverse irrigation equipment.

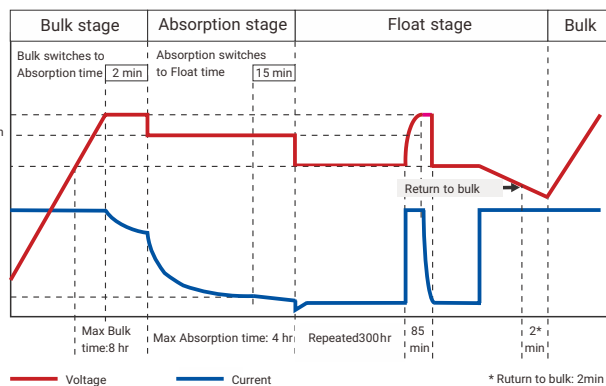
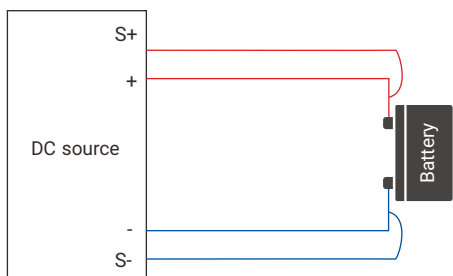

Battery Simulator Function

This series power supply built-in typical battery internal resistance curves and discharging curves can easily simulate battery behavior in real-case.

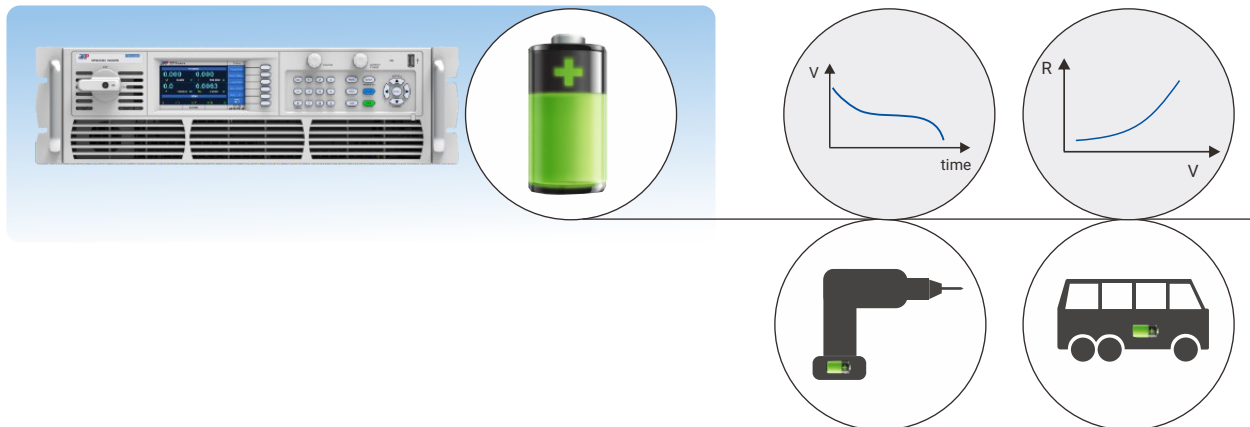

List/Program/Step Mode Programming

This series power supply provides List/Program/Step modes for output waveform programming. Users can edit the voltage/current value & the time of each step in advance and provide the power supply with a trigger signal. Then the preset sequences / waveform will be executed automatically according to the defined files. Sequence mode supports link between multiple files, the user can set the repeat times of each file and the total repeat times of the complete sequence file.

TTL/Analog Control and Monitoring

This series power supply provides TTL/Analog control and monitoring function, in this way the unit can be controlled and monitored easily by external instruments. The user can define the active level according to the actual requirement by themselves. The reserved port also can be used for the secondary development in the future.

SP-3U/6U Series Wide-range High-power Programmable DC Power Supply

MODEL		SP80VDC6000W	SP80VDC12000W	SP80VDC18000W
Input				
Voltage ^[1]		187~305VAC 340~480VAC		
Current ^[1]		3P208 L3-0, L1, L2-38A	3P208 L1-60A, L2,L3-38A	3P208 L1,L2,L3-60A
		3P400 L3-0, L1,L2-19A	3P400 L1-30A, L2,L3-19A	3P400 L1,L2,L3-30A
Frequency		45-65Hz		
Connection		2ph, PE	3ph, PE	3ph, PE
Fuse (Internal) ^[1]		T50A*2pcs		
		T30A*2pcs		
Power Factor		>0.99		
Input Power		3P208 7.1kVAmax, 3P400 6.9kVAmax	3P208 14.2kVAmax, 3P400 13.8kVAmax	3P208 21.3kVAmax, 3P400 20.7kVAmax
Efficiency ^[1]		3P208 ~90.5%@80V, 3P208 ~86.5%@200A	3P208 ~90.5%@80V, 3P208 ~86.5%@400A	3P208 ~90.5%@80V, 3P208 ~86.5%@600A
		3P400 ~92.2%@80V, 3P400 ~87.8%@200A	3P400 ~92.2%@80V, 3P400 ~87.8%@400A	3P400 ~92.2%@80V, 3P400 ~87.8%@600A
Output				
Voltage Range		0~80V		
Current Range ^[2]		0~200A	0~400A	0~600A
Power Range		0~6000W	0~12000W	0~18000W
Max. Setup Range	Voltage	0~84V(0~105%)		
	Current	0~202A(0~101%)	0~404A(0~101%)	0~606A(0~101%)
	Power	0~6150W(0~102.5%)	0~12300W(0~102.5%)	0~18450W(0~102.5%)
	Internal Resistance	0~12Ω	0~6Ω	0~4Ω
Accuracy	Voltage	<0.1% Umax(80mV)		
	Current	<0.2% I _{max} (400mA)	<0.2% I _{max} (800mA)	<0.2% I _{max} (1200mA)
	Power	<0.5%+30W	<0.5%+60W	<0.5%+90W
	Internal Resistance	R<2% R _{max} , I<0.3% I _{max}		
Line Regulation	Voltage	<0.02% Umax(16mV)		
	Current	<0.05% I _{max} (100mA)	<0.05% I _{max} (200mA)	<0.05% I _{max} (300mA)
	Power	<0.05% P _{max}		
Load Regulation ^[3]	Voltage	<0.05%Umax(40mV) @Rated Voltage, <0.1%Umax(80mV) @Rated Current		
	Current	<0.15% I _{max} (300mA)	<0.15% I _{max} (600mA)	<0.15% I _{max} (900mA)
	Power	<0.75% P _{max}		
Rise Time	Voltage	<15ms (No Load) <55ms (Full Load)		
Drop Time	Voltage	<850ms (No Load) <15ms (Full Load)		
Transient Response Time ^[4]	Voltage	≤1.5ms/0.8V		
Display Resolution	Voltage	0.001V		
	Current	0.001A		
	Power	0.1W		
	Internal Resistance	0.0001Ω		
Measurement Accuracy	Voltage	<0.1% Umax(80mV)		
	Current	<0.2% I _{max} (400mA)	<0.2% I _{max} (800mA)	<0.2% I _{max} (1200mA)
	Power	<0.5% P _{max}		
	Internal Resistance	<0.4% R _{max}		
Ripple ^[5]	Voltage	<180mVpp, <15mVrms	<288mVpp, <23mVrms	<320mVpp, <25mVrms
	Current	<100mArms	<200mArms	<300mArms
Remote Compensation	Voltage	5%Umax(4V)		
Sink Function				
Input Voltage		0~80V		
Input Current		0~100A	0~200A	0~300A
Input Power		0~335W	0~660W	0~1000W
Min. Operating Voltage		3V@100A	3V@200A	3V@300A
CC Resolution		10mA	20mA	30mA

SP-3U/6U Series Wide-range High-power Programmable DC Power Supply

MODEL	SP80VDC6000W	SP80VDC12000W	SP80VDC18000W
CC Accuracy	<0.2% I _{max} (200mA)	<0.2% I _{max} (400mA)	<0.2% I _{max} (600mA)
CV Resolution	<4mV		
CV Accuracy	<0.1% U _{max} (80mV)		
CP Resolution	0.5W	1W	1.5W
CP Accuracy	<0.5% P _{max} (1675mW)	<0.5% P _{max} (3300mW)	<0.5% P _{max} (5000mW)
Slew Rate	0.01~2.5A/us		
Dynamic Mode	20ms~50s		
General			
Graphic Display	4.3" Color touch LCD		
Operation Key Feature	Soft keys, Numeric keys, Rotary knob, USB port for transfer and upgrading firmware		
Rack Mount Handles	Yes		
FAN	Temperature control		
Protection	OCP, OVP, OPP, OTP, HARD FAIL		
Interface	RS232/RS485/USB(Standard), GPIB/LAN(Optional), CAN(Optional)		
Command Response Time	<3ms		
Analog Interface(Optional)			
Set Value Inputs	Analog input 0~5V/0~10V or 0~5kΩ/0~10kΩ to set 0~105% voltage, current and power		
Actual Value Output	Analog output 0~5V/0~10V to monitor the voltage and current.		
Accuracy U/I/P/R	<0.2% F.S		
Actual Output U/I	<0.2%		
Control Signals	DC ON/OFF, External control Enable/Disable		
Status Signals	CV, OVP, OT		
Sampling Rate of Input & Output	45Hz		
Galvanic Isolation to the Device	2121VDC		
Master/Slave Control			
Series Output	MAX 2 units		
Parallel Output	MAX 16 units		
Environmental			
Operating Temperature [2]	0~40°C		
Storage Temperature	-20~70°C		
Temperature Coefficient	100ppm/°C(voltage), 150ppm/°C(current)		
Relative Humidity	<95%RH(non-condensing)@35°C, <80%RH(non-condensing)@40°C		
Altitude	<2000m@40°C		
Fan Noise	45dB Idle; 71dB Max;	45dB Idle; 73dB Max;	45dB Idle; 75dB Max;
Mechanical			
Dimensions(WxHxD)	423.0x133.0x718.0 mm		
Package Dimensions(WxHxD)	665.0x347.0x1009.0 mm		
Unit Weight	27kg	38kg	50kg
Shipping Weight	37kg	48kg	60kg
Miscellaneous			
Over Voltage Category	II		
Protection Class	I		
Pollution Degree	2		
Insulation	AC input ↔ DC output, 4242VDC, AC input ↔ PE, 2818VDC		

[1] For different input voltage standard option must be specified at the time of order as they are installed at the factory prior to shipment.

[2] It is recommended that the output current is derated by 10% when the operation environment is higher than 30°C.

[3] Load transient from 0% to 100% of rated output.

[4] Test value at 100% voltage and 100% power.

[5] V_{rms} @ 300kHz, V_{pp} @ 20MHz, A_{rms} @ 300kHz.

SP-3U/6U Series Wide-range High-power Programmable DC Power Supply

MODEL	SP80VDC24000W	SP80VDC30000W	SP80VDC36000W	
Input				
Voltage ^[1]	196~305VAC 340~480VAC			
Current ^[1]	3P208 L3-60A , L1, L2-103A 3P400 L3-30A, L1,L2-49A	3P208 L1-125A,L2,L3-103A 3P400 L1-63A,L2,L3-49A	3P208 L1,L2,L3-125A 3P400 L1,L2,L3-63A	
Frequency	45-65Hz			
Connection	3ph, PE			
Fuse (Internal) ^[1]	T50A*2pcs T30A*2pcs			
Power Factor	>0.99			
Input Power	3P208 28.4kVAmax, 3P400 27.6kVAmax	3P208 35.5kVAmax, 3P400 34.5kVAmax	3P208 42.6kVAmax, 3P400 41.4kVAmax	
Efficiency ^[1]	3P208 ~90.5%@80V, 3P208 ~86.5%@800A 3P400 ~92.2%@80V, 3P400 ~87.8%@800A	3P208 ~90.5%@80V, 3P208 ~86.5%@1000A 3P400 ~92.2%@80V, 3P400 ~87.8%@1000A	3P208 ~90.5%@80V, 3P208 ~86.5%@1200A 3P400 ~92.2%@80V, 3P400 ~87.8%@1200A	
Output				
Voltage Range	0~80V			
Current Range ^[2]	0~800A	0~1000A	0~1200A	
Power Range	0~24000W	0~30000W	0~36000W	
Max. Setup Range	Voltage	0~84V(0~105%)		
	Current	0~808A(0~101%)	0~1010A(0~101%)	0~1212A(0~101%)
	Power	0~24600W(0~102.5%)	0~30750W(0~102.5%)	0~36900W(0~102.5%)
	Internal Resistance	0~3.0Ω	0~2.4Ω	0~2.0Ω
Accuracy	Voltage	<0.1% Umax(80mV)		
	Current	<0.2% I _{max} (1600mA)	<0.2% I _{max} (2000mA)	<0.2% I _{max} (2400mA)
	Power	<1%+120W	<1%+150W	<1%+180W
	Internal Resistance	R<2% R _{max} , I<0.3% I _{max}		
Line Regulation	Voltage	<0.02% Umax(16mV)		
	Current	<0.05% I _{max} (400mA)	<0.05% I _{max} (500mA)	<0.05% I _{max} (600mA)
	Power	<0.05% P _{max}		
Load Regulation ^[3]	Voltage	<0.05%Umax(40mV) @Rated Voltage, <0.1%Umax(80mV) @Rated Current		
	Current	<0.15% I _{max} (1200mA)	<0.15% I _{max} (1500mA)	<0.15% I _{max} (1800mA)
	Power	<0.75% P _{max}		
Rise Time	Voltage	<15ms (No Load) <30ms (Full Load)		
Drop Time	Voltage	<850ms (No Load) <15ms (Full Load)		
Transient Response Time ^[4]	Voltage	≤1.5ms/0.8V		
Display Resolution	Voltage	0.001V		
	Current	0.001A	0.01A	0.01A
	Power	0.1W		
	Internal Resistance	0.0001Ω		
Measurement Accuracy	Voltage	<0.1% Umax(80mV)		
	Current	<0.2% I _{max} (1600mA)	<0.2% I _{max} (2000mA)	<0.2% I _{max} (2400mA)
	Power	<0.5% P _{max}		
	Internal Resistance	<0.4% R _{max}		
Ripple ^[5]	Voltage	<320mVpp, <25mVrms		
	Current	<360mArms	<450mArms	<540mArms
Remote Compensation	Voltage	5% Umax(4V)		
Sink Function				
Input Voltage	0~80V			
Input Current	0~400A	0~500A	0~600A	
Input Power	0~1300W	0~1600W	0~2000W	
Min. Operating Voltage	3V@400A	3V@500A	3V@600A	
CC Resolution	40mA	50mA	60mA	

SP-3U/6U Series Wide-range High-power Programmable DC Power Supply

MODEL	SP80VDC24000W	SP80VDC30000W	SP80VDC36000W
CC Accuracy	<0.2% I _{max} (800mA)	<0.2% I _{max} (1000mA)	<0.2% I _{max} (1200mA)
CV Resolution	<4mV		
CV Accuracy	<0.1% U _{max} (80mV)		
CP Resolution	2W	2.5W	3W
CP Accuracy	<0.5% P _{max} (6500mW)	<0.5% P _{max} (8000mW)	<0.5% P _{max} (10000mW)
Slew Rate	0.01~2.5A/us		
Dynamic Mode	20ms~50s		
General			
Graphic Display	4.3" Color touch LCD		
Operation Key Feature	Soft keys, Numeric keys, Rotary knob, USB port for transfer and upgrading firmware		
Rack Mount Handles	Yes		
FAN	Temperature control		
Protection	OCP, OVP, OPP, OTP, HARD FAIL		
Interface	RS232/RS485/USB(Standard), GPIB/LAN(Optional), CAN(Optional)		
Command Response Time	<3ms		
Analog Interface(Optional)			
Set Value Inputs	Analog input 0~5V/0~10V or 0~5kΩ/0~10kΩ to set 0~105% voltage, current and power		
Actual Value Output	Analog output 0~5V/0~10V to monitor the voltage and current.		
Accuracy U/I/P/R	<0.2% F.S		
Actual Output U/I	<0.2%		
Control Signals	DC ON/OFF, External control Enable/Disable		
Status Signals	CV, OVP, OT		
Sampling Rate of Input & Output	45Hz		
Galvanic Isolation to the Device	2121VDC		
Master/Slave Control			
Series Output	MAX 2 units		
Parallel Output	MAX 16 units		
Environmental			
Operating Temperature [2]	0~40°C		
Storage Temperature	-20~70°C		
Temperature Coefficient	100ppm/°C(voltage), 150ppm/°C(current)		
Relative Humidity	<95%RH(non-condensing)@35°C, <80%RH(non-condensing)@40°C		
Altitude	<2000m@40°C		
Fan Noise	48dB Idle; 77dB Max;	48dB Idle; 80dB Max;	48dB Idle; 82dB Max;
Mechanical			
Dimensions(WxHxD)	423.0x265.0x745.0 mm		
Package Dimensions(WxHxD)	549.0x531.0x946.0 mm		
Unit Weight	75kg	86kg	97kg
Shipping Weight	101kg	112kg	123kg
Miscellaneous			
Over Voltage Category	II		
Protection Class	I		
Pollution Degree	2		
Insulation	AC input <->DC output, 4242VDC, AC input <-> PE, 2818VDC		

[1] For different input voltage standard option must be specified at the time of order as they are installed at the factory prior to shipment.

[2] It is recommended that the output current is derated by 10% when the operation environment is higher than 30°C.

[3] Load transient from 0% to 100% of rated output.

[4] Test value at 100% voltage and 100% power.

[5] V_{rms} @ 300kHz, V_{pp} @ 20MHz, A_{rms} @ 300kHz.

SP-3U/6U Series Wide-range High-power Programmable DC Power Supply

MODEL	SP165VDC12000W	SP165VDC24000W	SP165VDC36000W	
Input				
Voltage ^[1]	187~305VAC	196~305VAC	196~305VAC	
	340~480VAC	340~480VAC	340~480VAC	
Current ^[1]	3P208 L1-60A, L2,L3-38A	3P208 L3-60A,L1,L2-103A	3P208 L1,L2,L3-125A	
	3P400 L1-30A, L2,L3-19A	3P400 L3-30A,L1,L2-49A	3P400 L1,L2,L3-63A	
Frequency	45-65Hz			
Connection	3ph, PE			
Fuse (Internal) ^[1]	T50A*2pcs			
	T30A*2pcs			
Power Factor	>0.99			
Input Power	3P208 14.4kVAmx, 3P400 14.0kVAmx	3P208 28.8kVAmx, 3P400 28.0kVAmx	3P208 42.6kVAmx, 3P400 41.4kVAmx	
Efficiency ^[1]	3P208 ~90.5%@165V, 3P208 ~85%@180A	3P208 ~90.5%@165V, 3P208 ~85%@360A	3P208 ~90.5%@165V, 3P208 ~85%@540A	
	3P400 ~91.5%@165V, 3P400 ~85.5%@180A	3P400 ~91.5%@165V, 3P400 ~85.5%@360A	3P400 ~91.5%@165V, 3P400 ~85.5%@540A	
Output				
Voltage Range	0~165V			
Current Range ^[2]	0~180A	0~360A	0~540A	
Power Range	0~12000W	0~24000W	0~36000W	
Max. Setup Range	Voltage	0~173.25V(0~105%)		
	Current	0~181.8A(0~101%)	0~363.6A(0~101%)	0~545.4A(0~101%)
	Power	0~12300W(0~102.5%)	0~24600W(0~102.5%)	0~36900W(0~102.5%)
	Internal Resistance	0~27.5Ω	0~13.75Ω	0~9.167Ω
Accuracy	Voltage	<0.1% Umax(165mV)		
	Current	<0.2% Imax(360mA)	<0.2% Imax(720mA)	<0.2% Imax(1080mA)
	Power	<0.5%+60W	<1%+120W	<1%+180W
	Internal Resistance	R<2% Rmax, I<0.3% Imax		
Line Regulation	Voltage	<0.02% Umax(33mV)		
	Current	<0.05% Imax(90mA)	<0.05% Imax(180mA)	<0.05% Imax(270mA)
	Power	<0.05% Pmax		
Load Regulation ^[3]	Voltage	<0.05% Umax(82.5mV) @Rated Voltage, <0.1% Umax(165mV) @Rated Current		
	Current	<0.15% Imax(270mA)	<0.15% Imax(540mA)	<0.15% Imax(810mA)
	Power	<0.75% Pmax		
Rise Time	Voltage	<15ms (No Load) <30ms (Full Load)		
Drop Time	Voltage	<900ms (No Load) <15ms (Full Load)		
Transient Response Time ^[4]	Voltage	≤1.5ms/1.65V		
Display Resolution	Voltage	0.001V		
	Current	0.001A		
	Power	0.1W		
	Internal Resistance	0.0001Ω		
Measurement Accuracy	Voltage	<0.1% Umax(165mV)		
	Current	<0.2% Imax(360mA)	<0.2% Imax(720mA)	<0.2% Imax(1080mA)
	Power	<0.5% Pmax		
	Internal Resistance	<0.4% Rmax		
Ripple ^[5]	Voltage	<540mVpp, <50mVrms		
	Current	<100mArms	<200mArms	<300mArms
Remote Compensation	Voltage	2%Umax(3.3V)		
General				
Graphic Display	4.3" Color touch LCD			
Operation Key Feature	Soft keys, Numeric keys, Rotary knob, USB port for transfer and upgrading firmware			
Rack Mount Handles	Yes			
FAN	Temperature control			
Protection	OCP, OVP, OPP, OTP, HARD FAIL			

SP-3U/6U Series Wide-range High-power Programmable DC Power Supply

MODEL	SP165VDC12000W	SP165VDC24000W	SP165VDC36000W
Interface	RS232/RS485/USB(Standard), GPIB/LAN(Optional), CAN(Optional)		
Command Response Time	<3ms		
Analog Interface(Optional)			
Set Value Inputs	Analog input 0~5V/0~10V or 0~5kΩ/0~10kΩ to set 0~105% voltage, current and power		
Actual Value Output	Analog output 0~5V/0~10V to monitor the voltage and current.		
Accuracy U/I/P/R	<0.2% F.S		
Actual Output U/I	<0.2%		
Control Signals	DC ON/OFF, External control Enable/Disable		
Status Signals	CV, OVP, OT		
Sampling Rate of Input & Output	45Hz		
Galvanic Isolation to the Device	2121VDC		
Master/Slave Control			
Series Output	MAX 2 units		
Parallel Output	MAX 16 units		
Environmental			
Operating Temperature ^[2]	0~40°C		
Storage Temperature	-20~70°C		
Temperature Coefficient	100ppm/°C(voltage), 150ppm/°C(current)		
Relative Humidity	<95%RH(non-condensing)@35°C, <80%RH(non-condensing)@40°C		
Altitude	<2000m@40°C		
Fan Noise	45dB Idle; 73dB Max;	48dB Idle; 80dB Max;	48dB Idle; 82dB Max;
Mechanical			
Dimensions(WxHxD)	423.0x133.0x718.0 mm	423.0x265.0x745.0 mm	423.0x265.0x745.0 mm
Package Dimensions(WxHxD)	665.0x347.0x1009.0 mm	549.0x531.0x946.0 mm	549.0x531.0x946.0 mm
Unit Weight	38kg	75kg	97kg
Shipping Weight	48kg	101kg	123kg
Miscellaneous			
Over Voltage Category	II		
Protection Class	I		
Pollution Degree	2		
Insulation	AC input <->DC output, 4242VDC, AC input <-> PE, 2818VDC		

[1] For different input voltage standard option must be specified at the time of order as they are installed at the factory prior to shipment.

[2] It is recommended that the output current is derated by 10% when the operation environment is higher than 30°C.

[3] Load transient from 0% to 100% of rated output.

[4] Test value at 100% voltage and 100% power.

[5] Vrms @ 300kHz, Vpp @ 20MHz, Arms @ 300kHz.

SP-3U/6U Series Wide-range High-power Programmable DC Power Supply

MODEL		SP250VDC18000W
Input		
Voltage ^[1]		187~305VAC 340~480VAC
Current ^[1]		3P208 L1,L2,L3-60A 3P400 L1,L2,L3-30A
Frequency		45-65Hz
Connection		3ph, PE
Fuse (Internal) ^[1]		T50A*2pcs T30A*2pcs
Power Factor		>0.99
Input Power		3P208 21.5KVAmx, 3P400 20.9KVAmx
Efficiency ^[1]		3P208 ~90.5%@250V, 3P208 ~85%@180A 3P400 ~91.5%@250V, 3P400 ~85.5%@180A
Output		
Voltage Range		0~250V
Current Range ^[2]		0~180A
Power Range		0~18000W
Max. Setup Range	Voltage	0~262.5V(0~105%)
	Current	0~181.8A(0~101%)
	Power	0~18450W(0~102.5%)
	Internal Resistance	0~41.6667Ω
Accuracy	Voltage	<0.1% Umax(250mV)
	Current	<0.2% Imax(360mA)
	Power	<0.5%+90W
	Internal Resistance	R<2% Rmax, I<0.3% Imax
Line Regulation	Voltage	<0.02% Umax(50mV)
	Current	<0.05% Imax(90mA)
	Power	<0.05% Pmax
Load Regulation ^[3]	Voltage	<0.05% Umax(125mV) @Rated Voltage, <0.1% Umax(250mV) @Rated Current
	Current	<0.15% Imax(270mA)
	Power	<0.75% Pmax
Rise Time	Voltage	<15ms (No Load) <30ms (Full Load)
Drop Time	Voltage	<950ms (No Load) <15ms (Full Load)
Transient Response Time ^[4]	Voltage	≤1.5ms/2.5V
Display Resolution	Voltage	0.001V
	Current	0.001A
	Power	0.1W
	Internal Resistance	0.0001Ω
Measurement Accuracy	Voltage	<0.1% Umax(250mV)
	Current	<0.2% Imax(360mA)
	Power	<0.5% Pmax
	Internal Resistance	<0.4% Rmax
Ripple ^[5]	Voltage	<850mVpp, <75mVrms
	Current	<100mArms
Remote Compensation	Voltage	1%Umax(2.5V)
General		
Graphic Display		4.3" Color touch LCD
Operation Key Feature		Soft keys, Numeric keys, Rotary knob, USB port for transfer and upgrading firmware
Rack Mount Handles		Yes
FAN		Temperature control
Protection		OCP, OVP, OPP, OTP, HARD FAIL

SP-3U/6U Series Wide-range High-power Programmable DC Power Supply

MODEL	SP250VDC18000W
Interface	RS232/RS485/USB(Standard), GPIB/LAN(Optional), CAN(Optional)
Command Response Time	<3ms
Analog Interface(Optional)	
Set Value Inputs	Analog input 0~5V/0~10V or 0~5kΩ/0~10kΩ to set 0~105% voltage, current and power
Actual Value Output	Analog output 0~5V/0~10V to monitor the voltage and current.
Accuracy U/I/P/R	<0.2% F.S
Actual Output U/I	<0.2%
Control Signals	DC ON/OFF, External control Enable/Disable
Status Signals	CV, OVP, OT
Sampling Rate of Input & Output	45Hz
Galvanic Isolation to the Device	2121VDC
Master/Slave Control	
Series Output	MAX 2 units
Parallel Output	MAX 16 units
Environmental	
Operating Temperature ^[2]	0~40°C
Storage Temperature	-20~70°C
Temperature Coefficient	100ppm/°C(voltage), 150ppm/°C(current)
Relative Humidity	<95%RH(non-condensing)@35°C, <80%RH(non-condensing)@40°C
Altitude	<2000m@40°C
Fan Noise	45dB Idle; 75dB Max;
Mechanical	
Dimensions(WxHxD)	423.0x133.0x718.0 mm
Package Dimensions(WxHxD)	665.0x347.0x1009.0 mm
Unit Weight	50kg
Shipping Weight	60kg
Miscellaneous	
Over Voltage Category	II
Protection Class	I
Pollution Degree	2
Insulation	AC input <->DC output, 4242VDC, AC input <-> PE, 2818VDC

[1] For different input voltage standard option must be specified at the time of order as they are installed at the factory prior to shipment.

[2] It is recommended that the output current is derated by 10% when the operation environment is higher than 30°C.

[3] Load transient from 0% to 100% of rated output.

[4] Test value at 100% voltage and 100% power.

[5] Vrms @ 300kHz, Vpp @ 20MHz, Arms @ 300kHz.

SP-3U/6U Series Wide-range High-power Programmable DC Power Supply

MODEL		SP360VDC6000W	SP360VDC12000W	SP360VDC18000W
Input				
Voltage ^[1]		187~305VAC 340~480VAC		
Current ^[1]		3P208 L3-0, L1,L2-38A	3P208 L1-60A, L2,L3-38A	3P208 L1,L2,L3-60A
		3P400 L3-0, L1,L2-19A	3P400 L1-30A, L2,L3-19A	3P400 L1,L2,L3-30A
Frequency		45-65Hz		
Connection		2ph, PE	3ph, PE	3ph, PE
Fuse (Internal) ^[1]		T50A*2pcs		
		T30A*2pcs		
Power Factor		>0.99		
Input Power		3P208 6.7kVAmax, 3P400 6.5kVAmax	3P208 13.4kVAmax, 3P400 13.0kVAmax	3P208 20.1kVAmax, 3P400 19.5kVAmax
Efficiency ^[1]		3P208 ~94%@360V, 3P208 ~93%@42.5A	3P208 ~94%@360V, 3P208 ~93%@85A	3P208 ~94%@360V, 3P208 ~93%@127.5A
		3P400 ~96%@360V, 3P400 ~95%@42.5A	3P400 ~96%@360V, 3P400 ~95%@85A	3P400 ~96%@360V, 3P400 ~95%@127.5A
Output				
Voltage Range		0~360V		
Current Range		0~42.5A	0~85A	0~127.5A
Power Range		0~6000W	0~12000W	0~18000W
Max. Setup Range	Voltage	0~378V(0~105%)		
	Current	0~44.63A(0~105%)	0~89.25A(0~105%)	0~133.88A(0~105%)
	Power	0~6150W(0~102.5%)	0~12300W(0~102.5%)	0~18450W(0~102.5%)
	Internal Resistance	0~440Ω	0~220Ω	0~147Ω
Accuracy	Voltage	<0.1%Umax(360mV)		
	Current	<0.2%Imax(85mA)	<0.2%Imax(170mA)	<0.2%Imax(255mA)
	Power	<1%+60W	<1%+90W	<1%+120W
	Internal Resistance	R<2% Rmax, I<0.3% Imax		
Line Regulation	Voltage	<0.02% Umax(72mV)		
	Current	<0.05% Imax(22mA)	<0.05% Imax(43mA)	<0.05% Imax(64mA)
	Power	<0.05% Pmax		
Load Regulation ^[2]	Voltage	<0.05% Umax(180mV) @Rated Voltage, <0.1% Umax(360mV) @Rated Current		
	Current	<0.15% Imax(64mA)	<0.15% Imax(128mA)	<0.15% Imax(191mA)
	Power	<0.75% Pmax		
Rise Time	Voltage	<15ms (No Load) <80ms (Full Load)		
Drop Time	Voltage	<650ms (No Load) <15ms (Full Load)		
Transient Response Time ^[3]	Voltage	≤1.5ms/3.6V		
Display Resolution	Voltage	0.01V		
	Current	0.001A		
	Power	1W		
	Internal Resistance	0.001Ω		
Measurement Accuracy	Voltage	<0.1% Umax(360mV)		
	Current	<0.2% Imax(85mA)	<0.2% Imax(170mA)	<0.2% Imax(255mA)
	Power	<0.5% Pmax		
	Internal Resistance	<0.4% Rmax		
Ripple ^[4]	Voltage	<320mVpp, <55mVrms		
	Current	<21mArms	<43mArms	<64mArms
Remote Compensation	Voltage	3%Umax(10.8V)		
Sink Function				
Input Voltage		0~360V		
Input Current		0~16A	0~24A	0~40A
Input Power		0~325W	0~650W	0~975W
Min. Operating Voltage		8V@16A	8V@24A	8V@40A
CC Resolution		1mA	2mA	3mA

SP-3U/6U Series Wide-range High-power Programmable DC Power Supply

MODEL	SP360VDC6000W	SP360VDC12000W	SP360VDC18000W
CC Accuracy	<0.2% I _{max} (32mA)	<0.2% I _{max} (48mA)	<0.2% I _{max} (80mA)
CV Resolution	<20mV		
CV Accuracy	<0.1% U _{max} (360mV)		
CP Resolution	0.5W	1.0W	1.5W
CP Accuracy	<0.5% P _{max} (1625mW)	<0.5% P _{max} (3250mW)	<0.5% P _{max} (4875mW)
Slew Rate	0.01~2.5A/us		
Dynamic Mode	20ms~50s		
General			
Graphic Display	4.3" Color touch LCD		
Operation Key Feature	Soft keys, Numeric keys, Rotary knob, USB port for transfer and upgrading firmware		
Rack Mount Handles	Yes		
FAN	Temperature control		
Protection	OCP, OVP, OPP, OTP, HARD FAIL		
Interface	RS232/RS485/USB(Standard), GPIB/LAN(Optional), CAN(Optional)		
Command Response Time	<3ms		
Analog Interface(Optional)			
Set Value Inputs	Analog input 0~5V/0~10V or 0~5kΩ/0~10kΩ to set 0~105% voltage, current and power		
Actual Value Output	Analog output 0~5V/0~10V to monitor the voltage and current.		
Accuracy U/I/P/R	<0.2% F.S		
Actual Output U/I	<0.2%		
Control Signals	DC ON/OFF, External control Enable/Disable		
Status Signals	CV, OVP, OT		
Sampling Rate of Input & Output	45Hz		
Galvanic Isolation to the Device	2818VDC		
Master/Slave Control			
Series Output	MAX 2 units		
Parallel Output	MAX 16 units		
Environmental			
Operating Temperature	0~40°C		
Storage Temperature	-20~70°C		
Temperature Coefficient	100ppm/°C(voltage), 150ppm/°C(current)		
Relative Humidity	<95%RH(non-condensing)@35°C, <80%RH(non-condensing)@40°C		
Altitude	<2000m@40°C		
Fan Noise	45dB Idle; 71dB Max;	45dB Idle; 73dB Max;	45dB Idle; 75dB Max;
Mechanical			
Dimensions(WxHxD)	423.0x133.0x718.0 mm		
Package Dimensions(WxHxD)	665.0x347.0x1009.0 mm		
Unit Weight	27kg	38kg	50kg
Shipping Weight	37kg	48kg	60kg
Miscellaneous			
Over Voltage Category	II		
Protection Class	I		
Pollution Degree	2		
Insulation	AC input <->DC output, 4242VDC, AC input <-> PE, 2818VDC		

[1] For different input voltage standard option must be specified at the time of order as they are installed at the factory prior to shipment.

[2] Load transient from 0% to 100% of rated output.

[3] Test value at 100% voltage and 100% power.

[4] V_{rms} @ 300kHz, V_{pp} @ 20MHz, A_{rms} @ 300kHz.

SP-3U/6U Series Wide-range High-power Programmable DC Power Supply

MODEL	SP360VDC24000W	SP360VDC30000W	SP360VDC36000W		
Input					
Voltage ^[1]	196~305VAC 340~480VAC				
Current ^[1]	3P208 L3-60A , L1, L2-103A 3P400 L3-30A, L1,L2-49A	3P208 L1-125A,L2,L3-103A 3P400 L1-63A,L2,L3-49A	3P208 L1,L2,L3-125A 3P400 L1,L2,L3-63A		
Frequency	45-65Hz				
Connection	3ph, PE				
Fuse (Internal) ^[1]	T50A*2pcs T30A*2pcs				
Power Factor	>0.99				
Input Power	3P208 26.8kVAmax, 3P400 26.0kVAmax	3P208 33.5kVAmax, 3P400 32.5kVAmax	3P208 40.2kVAmax, 3P400 39.0kVAmax		
Efficiency ^[1]	3P208 ~94%@360V, 3P208 ~93%@170A 3P400 ~95%@360V, 3P400 ~96%@170A	3P208 ~94%@360V, 3P208 ~93%@212.5A 3P400 ~95%@360V, 3P400 ~96%@212.5A	3P208 ~94%@360V, 3P208 ~93%@255A 3P400 ~95%@360V, 3P400 ~96%@255A		
Output					
Voltage Range	0~360V				
Current Range	0~170A	0~212.5A	0~255A		
Power Range	0~24000W	0~30000W	0~36000W		
Max. Setup Range	Voltage	0~378V(0~105%)			
	Current	0~173.4A(0~102%)	0~216.75A(0~102%)	0~260.1A(0~102%)	
	Power	0~24600W(0~102.5%)		0~30750W(0~102.5%)	0~36900W(0~102.5%)
	Internal Resistance	0~64Ω	0~51Ω	0~43Ω	
Accuracy	Voltage	<0.1%Umax(360mV)			
	Current	<0.2%Imax(340mA)	<0.2%Imax(425mA)	<0.2%Imax(510mA)	
	Power	<1%+180W	<1%+240W	<1%+360W	
	Internal Resistance	R<2% Rmax, I<0.3% Imax			
Line Regulation	Voltage	<0.02% Umax(72mV)			
	Current	<0.05% Imax(85mA)	<0.05% Imax(106mA)	<0.05% Imax(128mA)	
	Power	<0.05% Pmax			
Load Regulation ^[2]	Voltage	<0.05% Umax(180mV) @Rated Voltage, <0.1% Umax(360mV) @Rated Current			
	Current	<0.15% Imax(255mA)	<0.15% Imax(319mA)	<0.15% Imax(383mA)	
	Power	<0.75% Pmax			
Rise Time	Voltage	<15ms (No Load) <80ms (Full Load)			
Drop Time	Voltage	<650ms (No Load) <15ms (Full Load)			
Transient Response Time ^[3]	Voltage	≤1.5ms/3.6V			
Display Resolution	Voltage	0.01V			
	Current	0.001A			
	Power	1W			
	Internal Resistance	0.001Ω			
Measurement Accuracy	Voltage	<0.1% Umax(360mV)			
	Current	<0.2% Imax(340mA)	<0.2% Imax(425mA)	<0.2% Imax(510mA)	
	Power	<0.5% Pmax			
	Internal Resistance	<0.4% Rmax			
Ripple ^[4]	Voltage	<350mVpp, <60mVrms			
	Current	<85mArms	<106mArms	<128mArms	
Remote Compensation	Voltage	3%Umax(10.8V)			
Sink Function					
Input Voltage	0~360V				
Input Current	0~56A	0~64A	0~80A		
Input Power	0~1300W	0~1625W	0~1950W		
Min. Operating Voltage	8V@56A	8V@64A	8V@80A		
CC Resolution	4mA	5mA	6mA		

SP-3U/6U Series Wide-range High-power Programmable DC Power Supply

MODEL	SP360VDC24000W	SP360VDC30000W	SP360VDC36000W
CC Accuracy	<0.2% I _{max} (112mA)	<0.2% I _{max} (128mA)	<0.2% I _{max} (160mA)
CV Resolution	<20mV		
CV Accuracy	<0.1% U _{max} (360mV)		
CP Resolution	2W	2.5W	3W
CP Accuracy	<0.5% P _{max} (6500mW)	<0.5% P _{max} (8125mW)	<0.5% P _{max} (9750mW)
Slew Rate	0.01~2.5A/us		
Dynamic Mode	20ms~50s		
General			
Graphic Display	4.3" Color touch LCD		
Operation Key Feature	Soft keys, Numeric keys, Rotary knob, USB port for transfer and upgrading firmware		
Rack Mount Handles	Yes		
FAN	Temperature control		
Protection	OCP, OVP, OPP, OTP, HARD FAIL		
Interface	RS232/RS485/USB(Standard), GPIB/LAN(Optional), CAN(Optional)		
Command Response Time	<3ms		
Analog Interface(Optional)			
Set Value Inputs	Analog input 0~5V/0~10V or 0~5kΩ/0~10kΩ to set 0~105% voltage, current and power		
Actual Value Output	Analog output 0~5V/0~10V to monitor the voltage and current.		
Accuracy U/I/P/R	<0.2% F.S		
Actual Output U/I	<0.2%		
Control Signals	DC ON/OFF, External control Enable/Disable		
Status Signals	CV, OVP, OT		
Sampling Rate of Input & Output	45Hz		
Galvanic Isolation to the Device	2818VDC		
Master/Slave Control			
Series Output	MAX 2 units		
Parallel Output	MAX 16 units		
Environmental			
Operating Temperature	0~40°C		
Storage Temperature	-20~70°C		
Temperature Coefficient	100ppm/°C(voltage), 150ppm/°C(current)		
Relative Humidity	<95%RH(non-condensing)@35°C, <80%RH(non-condensing)@40°C		
Altitude	<2000m@40°C		
Fan Noise	48dB Idle; 77dB Max;	48dB Idle; 80dB Max;	48dB Idle; 82dB Max;
Mechanical			
Dimensions(WxHxD)	423.0x265.0x745.0 mm		
Package Dimensions(WxHxD)	549.0x531.0x946.0 mm		
Unit Weight	75kg	86kg	97kg
Shipping Weight	101kg	112kg	123kg
Miscellaneous			
Over Voltage Category	II		
Protection Class	I		
Pollution Degree	2		
Insulation	AC input <->DC output, 4242VDC, AC input <-> PE, 2818VDC		

[1] For different input voltage standard option must be specified at the time of order as they are installed at the factory prior to shipment.

[2] Load transient from 0% to 100% of rated output.

[3] Test value at 100% voltage and 100% power.

[4] V_{rms} @ 300kHz, V_{pp} @ 20MHz, A_{rms} @ 300kHz.

SP-3U/6U Series Wide-range High-power Programmable DC Power Supply

MODEL	SP500VDC6000W	SP500VDC12000W	SP500VDC18000W	
Input				
Voltage ^[1]	187~305VAC 340~480VAC			
Current ^[1]	3P208 L3-0, L1,L2-38A 3P400 L3-0, L1,L2-19A	3P208 L1-60A, L2,L3-38A 3P400 L1-30A, L2,L3-19A	3P208 L1,L2,L3-60A 3P400 L1,L2,L3-30A	
Frequency	45-65Hz			
Connection	2ph, PE	3ph, PE	3ph, PE	
Fuse (Internal) ^[1]	T50A*2pcs T30A*2pcs			
Power Factor	>0.99			
Input Power	3P208 6.7kVAmax, 3P400 6.5kVAmax	3P208 13.4kVAmax, 3P400 13.0kVAmax	3P208 20.1kVAmax, 3P400 19.5kVAmax	
Efficiency ^[1]	3P208 ~92.5%@500V, 3P208 ~91%@32A 3P400 ~94%@500V, 3P400 ~92.5%@32A	3P208 ~92.5%@500V, 3P208 ~91%@64A 3P400 ~94%@500V, 3P400 ~92.5%@64A	3P208 ~92.5%@500V, 3P208 ~91%@96A 3P400 ~94%@500V, 3P400 ~92.5%@96A	
Output				
Voltage Range	0~500V			
Current Range	0~32A	0~64A	0~96A	
Power Range	0~6000W	0~12000W	0~18000W	
Max. Setup Range	Voltage	0~525V(0~105%)		
	Current	0~33.6A(0~105%)	0~67.2A(0~105%)	0~100.8A(0~105%)
	Power	0~6150W(0~102.5%)	0~12300W(0~102.5%)	0~18450W(0~102.5%)
	Internal Resistance	0~469Ω	0~235Ω	0~157Ω
Accuracy	Voltage	<0.1% Umax(500mV)		
	Current	<0.2% I _{max} (64mA)	<0.2% I _{max} (128mA)	<0.2% I _{max} (192mA)
	Power	<1%+60W	<1%+90W	<1%+120W
	Internal Resistance	R<2% R _{max} , I<0.3% I _{max}		
Line Regulation	Voltage	<0.02% Umax(100mV)		
	Current	<0.05% I _{max} (16mA)	<0.05% I _{max} (32mA)	<0.05% I _{max} (48mA)
	Power	<0.05% P _{max}		
Load Regulation ^[2]	Voltage	<0.05% Umax(250mV) @Rated Voltage, <0.1% Umax(500mV) @Rated Current		
	Current	<0.15% I _{max} (48mA)	<0.15% I _{max} (96mA)	<0.15% I _{max} (144mA)
	Power	<0.75% P _{max}		
Rise Time	Voltage	<15ms (No Load) <80ms (Full Load)		
Drop Time	Voltage	<1500ms (No Load) <15ms (Full Load)		
Transient Response Time ^[3]	Voltage	≤1.5ms/5V		
Display Resolution	Voltage	0.01V		
	Current	0.001A		
	Power	1W		
	Internal Resistance	0.001Ω		
Measurement Accuracy	Voltage	<0.1% Umax(500mV)		
	Current	<0.2% I _{max} (64mA)	<0.2% I _{max} (128mA)	<0.2% I _{max} (192mA)
	Power	<0.5% P _{max}		
	Internal Resistance	<0.4% R _{max}		
Ripple ^[4]	Voltage	<600mVpp, <150mVrms	<650mVpp, <160mVrms	<650mVpp, <160mVrms
	Current	<16mArms	<32mArms	<48mArms
Remote Compensation	Voltage	3%Umax(15V)		
Sink Function				
Input Voltage	0~500V			
Input Current	0~16A	0~24A	0~40A	
Input Power	0~325W	0~650W	0~975W	
Min. Operating Voltage	8V@16A	8V@24A	8V@40A	
CC Resolution	1mA	2mA	3mA	

SP-3U/6U Series Wide-range High-power Programmable DC Power Supply

MODEL	SP500VDC6000W	SP500VDC12000W	SP500VDC18000W
CC Accuracy	<0.2% I _{max} (32mA)	<0.2% I _{max} (48mA)	<0.2% I _{max} (80mA)
CV Resolution	<4mV		
CV Accuracy	<0.1% U _{max} (500mV)		
CP Resolution	0.5W	1.0W	1.5W
CP Accuracy	<0.5% P _{max} (1625mW)	<0.5% P _{max} (3250mW)	<0.5% P _{max} (4875mW)
Slew Rate	0.01~2.5A/us		
Dynamic Mode	20ms~50s		
General			
Graphic Display	4.3" Color touch LCD		
Operation Key Feature	Soft keys, Numeric keys, Rotary knob, USB port for transfer and upgrading firmware		
Rack Mount Handles	Yes		
FAN	Temperature control		
Protection	OCP, OVP, OPP, OTP, HARD FAIL		
Interface	RS232/RS485/USB(Standard), GPIB/LAN(Optional), CAN(Optional)		
Command Response Time	<3ms		
Analog Interface(Optional)			
Set Value Inputs	Analog input 0~5V/0~10V or 0~5kΩ/0~10kΩ to set 0~105% voltage, current and power		
Actual Value Output	Analog output 0~5V/0~10V to monitor the voltage and current.		
Accuracy U/I/P/R	<0.2% F.S		
Actual Output U/I	<0.2%		
Control Signals	DC ON/OFF, External control Enable/Disable		
Status Signals	CV, OVP, OT		
Sampling Rate of Input & Output	45Hz		
Galvanic Isolation to the Device	2818VDC		
Master/Slave Control			
Series Output	MAX 2 units		
Parallel Output	MAX 16 units		
Environmental			
Operating Temperature	0~40°C		
Storage Temperature	-20~70°C		
Temperature Coefficient	100ppm/°C(voltage), 150ppm/°C(current)		
Relative Humidity	<95%RH(non-condensing)@35°C, <80%RH(non-condensing)@40°C		
Altitude	<2000m@40°C		
Fan Noise	45dB Idle; 71dB Max;	45dB Idle; 73dB Max;	45dB Idle; 75dB Max;
Mechanical			
Dimensions(WxHxD)	423.0x133.0x718.0 mm		
Package Dimensions(WxHxD)	665.0x347.0x1009.0 mm		
Unit Weight	27kg	38kg	50kg
Shipping Weight	37kg	48kg	60kg
Miscellaneous			
Over Voltage Category	II		
Protection Class	I		
Pollution Degree	2		
Insulation	AC input <->DC output, 4242VDC, AC input <-> PE, 2818VDC		

[1] For different input voltage standard option must be specified at the time of order as they are installed at the factory prior to shipment.

[2] Load transient from 0% to 100% of rated output.

[3] Test value at 100% voltage and 100% power.

[4] V_{rms} @ 300kHz, V_{pp} @ 20MHz, A_{rms} @ 300kHz.

SP-3U/6U Series Wide-range High-power Programmable DC Power Supply

MODEL	SP500VDC24000W	SP500VDC30000W	SP500VDC36000W	
Input				
Voltage ^[1]	196~305VAC 340~480VAC			
Current ^[1]	3P208 L1-60A, L2,L3-103A 3P400 L1-30A, L2,L3-49A	3P208 L1-125A,L2,L3-103A 3P400 L1-63A,L2,L3-49A	3P208 L1,L2,L3-125A 3P400 L1,L2,L3-63A	
Frequency	45-65Hz			
Connection	3ph, PE			
Fuse (Internal) ^[1]	T50A*2pcs T30A*2pcs			
Power Factor	>0.99			
Input Power	3P208 26.8kVAm _{ax} , 3P400 26.0kVAm _{ax}	3P208 33.5kVAm _{ax} , 3P400 32.5kVAm _{ax}	3P208 40.2kVAm _{ax} , 3P400 39.0kVAm _{ax}	
Efficiency ^[1]	3P208 ~92.5%@500V, 3P208 ~91%@128A 3P400 ~94%@500V, 3P400 ~92.5%@128A	3P208 ~92.5%@500V, 3P208 ~91%@160A 3P400 ~94%@500V, 3P400 ~92.5%@160A	3P208 ~92.5%@500V, 3P208 ~91%@192A 3P400 ~94%@500V, 3P400 ~92.5%@192A	
Output				
Voltage Range	0~500V			
Current Range	0~128A	0~160A	0~192A	
Power Range	0~24000W	0~30000W	0~36000W	
Max. Setup Range	Voltage	0~525V(0~105%)		
	Current	0~130.56A(0~102%)	0~163.2A(0~102%)	0~195.84A(0~102%)
	Power	0~24600W(0~102.5%)	0~30750W(0~102.5%)	0~36900W(0~102.5%)
	Internal Resistance	0~118Ω	0~94Ω	0~79Ω
Accuracy	Voltage	<0.1% U _{max} (500mV)		
	Current	<0.2% I _{max} (256mA)	<0.2% I _{max} (320mA)	<0.2% I _{max} (384mA)
	Power	<1%+180W	<1%+240W	<1%+360W
	Internal Resistance	R<2% R _{max} , I<0.3% I _{max}		
Line Regulation	Voltage	<0.02% U _{max} (100mV)		
	Current	<0.05% I _{max} (64mA)	<0.05% I _{max} (80mA)	<0.05% I _{max} (96mA)
	Power	<0.05% P _{max}		
Load Regulation ^[2]	Voltage	<0.05% U _{max} (250mV) @Rated Voltage, <0.1% U _{max} (500mV) @Rated Current		
	Current	<0.15% I _{max} (192mA)	<0.15% I _{max} (240mA)	<0.15% I _{max} (288mA)
	Power	<0.75% P _{max}		
Rise Time	Voltage	<15ms (No Load) <80ms (Full Load)		
Drop Time	Voltage	<1500ms (No Load) <15ms (Full Load)		
Transient Response Time ^[3]	Voltage	≤1.5ms/5V		
Display Resolution	Voltage	0.01V		
	Current	0.001A		
	Power	1W		
	Internal Resistance	0.001Ω		
Measurement Accuracy	Voltage	<0.1% U _{max} (500mV)		
	Current	<0.2% I _{max} (256mA)	<0.2% I _{max} (320mA)	<0.2% I _{max} (384mA)
	Power	<0.5% P _{max}		
	Internal Resistance	<0.4% R _{max}		
Ripple ^[4]	Voltage	<650mV _{pp} , <160mV _{rms}		
	Current	<64mArms	<80mArms	<96mArms
Remote Compensation	Voltage	3% U _{max} (15V)		
Sink Function				
Input Voltage	0~500V			
Input Current	0~56A	0~64A	0~80A	
Input Power	0~1300W	0~1625W	0~1950W	
Min. Operating Voltage	8V@56A	8V@64A	8V@80A	
CC Resolution	4mA	5mA	6mA	

SP-3U/6U Series Wide-range High-power Programmable DC Power Supply

MODEL	SP500VDC24000W	SP500VDC30000W	SP500VDC36000W
CC Accuracy	<0.2% I _{max} (112mA)	<0.2% I _{max} (128mA)	<0.2% I _{max} (160mA)
CV Resolution	<4mV		
CV Accuracy	<0.1% U _{max} (500mV)		
CP Resolution	2W	2.5W	3W
CP Accuracy	<0.5% P _{max} (6500mW)	<0.5% P _{max} (8125mW)	<0.5% P _{max} (9750mW)
Slew Rate	0.01~2.5A/us		
Dynamic Mode	20ms~50s		
General			
Graphic Display	4.3" Color touch LCD		
Operation Key Feature	Soft keys, Numeric keys, Rotary knob, USB port for transfer and upgrading firmware		
Rack Mount Handles	Yes		
FAN	Temperature control		
Protection	OCP, OVP, OPP, OTP, HARD FAIL		
Interface	RS232/RS485/USB(Standard), GPIB/LAN(Optional), CAN(Optional)		
Command Response Time	<3ms		
Analog Interface(Optional)			
Set Value Inputs	Analog input 0~5V/0~10V or 0~5kΩ/0~10kΩ to set 0~105% voltage, current and power		
Actual Value Output	Analog output 0~5V/0~10V to monitor the voltage and current.		
Accuracy U/I/P/R	<0.2% F.S		
Actual Output U/I	<0.2%		
Control Signals	DC ON/OFF, External control Enable/Disable		
Status Signals	CV, OVP, OT		
Sampling Rate of Input & Output	45Hz		
Galvanic Isolation to the Device	2818VDC		
Master/Slave Control			
Series Output	MAX 2 units		
Parallel Output	MAX 16 units		
Environmental			
Operating Temperature	0~40°C		
Storage Temperature	-20~70°C		
Temperature Coefficient	100ppm/°C(voltage), 150ppm/°C(current)		
Relative Humidity	<95%RH(non-condensing)@35°C, <80%RH(non-condensing)@40°C		
Altitude	<2000m@40°C		
Fan Noise	48dB Idle; 77dB Max;	48dB Idle; 80dB Max;	48dB Idle; 82dB Max;
Mechanical			
Dimensions(WxHxD)	423.0x265.0x745.0 mm		
Package Dimensions(WxHxD)	549.0x531.0x946.0 mm		
Unit Weight	75kg	86kg	97kg
Shipping Weight	101kg	112kg	123kg
Miscellaneous			
Over Voltage Category	II		
Protection Class	I		
Pollution Degree	2		
Insulation	AC input <->DC output, 4242VDC, AC input <-> PE, 2818VDC		

[1] For different input voltage standard option must be specified at the time of order as they are installed at the factory prior to shipment.

[2] Load transient from 0% to 100% of rated output.

[3] Test value at 100% voltage and 100% power.

[4] V_{rms} @ 300kHz, V_{pp} @ 20MHz, A_{rms} @ 300kHz.

SP-3U/6U Series Wide-range High-power Programmable DC Power Supply

MODEL	SP750VDC6000W	SP750VDC12000W	SP750VDC18000W	
Input				
Voltage ^[1]	187~305VAC 340~480VAC			
Current ^[1]	3P208 L3-0, L1,L2-38A 3P400 L3-0, L1,L2-19A	3P208 L1-60A, L2,L3-38A 3P400 L1-30A, L2,L3-19A	3P208 L1,L2,L3-60A 3P400 L1,L2,L3-30A	
Frequency	45-65Hz			
Connection	2ph, PE	3ph, PE	3ph, PE	
Fuse (Internal) ^[1]	T50A*2pcs T30A*2pcs			
Power Factor	>0.99			
Input Power	3P208 6.7KVAmx, 3P400 6.5KVAmx	3P208 13.4KVAmx, 3P400 13.0KVAmx	3P208 20.1KVAmx, 3P400 19.5KVAmx	
Efficiency ^[1]	3P208 ~92.5%@750V, 3P208 ~91%@21A 3P400 ~92.7%@750V, 3P400 ~92%@21A	3P208 ~92.5%@750V, 3P208 ~91%@42A 3P400 ~92.7%@750V, 3P400 ~92%@42A	3P208 ~92.5%@750V, 3P208 ~91%@63A 3P400 ~92.7%@750V, 3P400 ~92%@63A	
Output				
Voltage Range	0~750V			
Current Range	0~21A	0~42A	0~63A	
Power Range	0~6000W	0~12000W	0~18000W	
Max. Setup Range	Voltage	0~787.5V(0~105%)		
	Current	0~22.05A(0~105%)	0~44.1A(0~105%)	0~66.15A(0~105%)
	Power	0~61500W(0~102.5%)	0~12300W(0~102.5%)	0~18450W(0~102.5%)
	Internal Resistance	0~1072Ω	0~536Ω	0~358Ω
Accuracy	Voltage	<0.1% U _{max} (750mV)		
	Current	<0.2% I _{max} (42mA)	<0.2% I _{max} (84mA)	<0.2% I _{max} (126mA)
	Power	<1%+60W	<1%+90W	<1%+120W
	Internal Resistance	R<2% R _{max} , I<0.3% I _{max}		
Line Regulation	Voltage	<0.02% U _{max} (150mV)		
	Current	<0.05% I _{max} (10.5mA)	<0.05% I _{max} (21mA)	<0.05% I _{max} (31.5mA)
	Power	<0.05% P _{max}		
Load Regulation ^[2]	Voltage	<0.05% U _{max} (375mV) @Rated Voltage, <0.1% U _{max} (750mV) @Rated Current		
	Current	<0.15% I _{max} (31.5mA)	<0.15% I _{max} (63mA)	<0.15% I _{max} (94.5mA)
	Power	<0.75% P _{max}		
Rise Time	Voltage	<15ms (No Load) <80ms (Full Load)		
Drop Time	Voltage	<600ms (No Load) <20ms (Full Load)		
Transient Response Time ^[3]	Voltage	≤2ms/7.5V		
Display Resolution	Voltage	0.01V		
	Current	0.001A		
	Power	1W		
	Internal Resistance	0.001Ω		
Measurement Accuracy	Voltage	<0.1% U _{max} (750mV)		
	Current	<0.2% I _{max} (42mA)	<0.2% I _{max} (84mA)	<0.2% I _{max} (126mA)
	Power	<0.5% P _{max}		
	Internal Resistance	<0.4% R _{max}		
Ripple ^[4]	Voltage	<900mVpp, <225mVrms	<1000mVpp, <250mVrms	<1000mVpp, <250mVrms
	Current	<11mArms	<22mArms	<33mArms
Remote Compensation	Voltage	3% U _{max} (22.5V)		
Sink Function				
Input Voltage	0~750V			
Input Current	0~10A	0~15A	0~25A	
Input Power	0~325W	0~650W	0~975W	
Min. Operating Voltage	5V@10A	5V@15A	5V@25A	
CC Resolution	1mA	2mA	3mA	

SP-3U/6U Series Wide-range High-power Programmable DC Power Supply

MODEL	SP750VDC6000W	SP750VDC12000W	SP750VDC18000W
CC Accuracy	<0.2% I _{max} (20mA)	<0.2% I _{max} (30mA)	<0.2% I _{max} (50mA)
CV Resolution	<4mV		
CV Accuracy	<0.1% U _{max} (750mV)		
CP Resolution	0.5W	1.0W	1.5W
CP Accuracy	<0.5% P _{max} (1625mW)	<0.5% P _{max} (3250mW)	<0.5% P _{max} (4875mW)
Slew Rate	0.01~2.5A/us		
Dynamic Mode	20ms~50s		
General			
Graphic Display	4.3" Color touch LCD		
Operation Key Feature	Soft keys, Numeric keys, Rotary knob, USB port for transfer and upgrading firmware		
Rack Mount Handles	Yes		
FAN	Temperature control		
Protection	OCP, OVP, OPP, OTP, HARD FAIL		
Interface	RS232/RS485/USB(Standard), GPIB/LAN(Optional), CAN(Optional)		
Command Response Time	<3ms		
Analog Interface(Optional)			
Set Value Inputs	Analog input 0~5V/0~10V or 0~5kΩ/0~10kΩ to set 0~105% voltage, current and power		
Actual Value Output	Analog output 0~5V/0~10V to monitor the voltage and current.		
Accuracy U/I/P/R	<0.2% F.S		
Actual Output U/I	<0.2%		
Control Signals	DC ON/OFF, External control Enable/Disable		
Status Signals	CV, OVP, OT		
Sampling Rate of Input & Output	45Hz		
Galvanic Isolation to the Device	4242VDC		
Master/Slave Control			
Series Output	MAX 2 units		
Parallel Output	MAX 16 units		
Environmental			
Operating Temperature	0~40°C		
Storage Temperature	-20~70°C		
Temperature Coefficient	100ppm/°C(voltage), 150ppm/°C(current)		
Relative Humidity	<95%RH(non-condensing)@35°C, <80%RH(non-condensing)@40°C		
Altitude	<2000m@40°C		
Fan Noise	45dB Idle; 71dB Max;	45dB Idle; 73dB Max;	45dB Idle; 75dB Max;
Mechanical			
Dimensions(WxHxD)	423.0x133.0x718.0 mm		
Package Dimensions(WxHxD)	665.0x347.0x1009.0 mm		
Unit Weight	27kg	38kg	50kg
Shipping Weight	37kg	48kg	60kg
Miscellaneous			
Over Voltage Category	II		
Protection Class	I		
Pollution Degree	2		
Insulation	AC input <->DC output, 4242VDC, AC input <-> PE, 2818VDC		

[1] For different input voltage standard option must be specified at the time of order as they are installed at the factory prior to shipment.

[2] Load transient from 0% to 100% of rated output.

[3] Test value at 100% voltage and 100% power.

[4] V_{rms} @ 300kHz, V_{pp} @ 20MHz, A_{rms} @ 300kHz.

SP-3U/6U Series Wide-range High-power Programmable DC Power Supply

MODEL		SP750VDC24000W	SP750VDC30000W	SP750VDC36000W
Input				
Voltage ^[1]		196~305VAC		
		340~480VAC		
Current ^[1]		3P208 L3-60A, L1,L2-103A	3P208 L1-125A,L2,L3-103A	3P208 L1,L2,L3-125A
		3P400 L3-30A, L1,L2-49A	3P400 L1-63A,L2,L3-49A	3P400 L1,L2,L3-63A
Frequency		45-65Hz		
Connection		3ph, PE		
Fuse (Internal) ^[1]		T50A*2pcs		
		T30A*2pcs		
Power Factor		>0.99		
Input Power		3P208 26.8KVAmx, 3P400 26.0KVAmx	3P208 33.5KVAmx, 3P400 32.5KVAmx	3P208 40.2KVAmx, 3P400 39.0KVAmx
Efficiency ^[1]		3P208 ~92.5%@750V, 3P208 ~91%@84A	3P208 ~92.5%@750V, 3P208 ~91%@105A	3P208 ~92.5%@750V, 3P208 ~91%@126A
		3P400 ~92.7%@750V, 3P400 ~92%@84A	3P400 ~92.7%@750V, 3P400 ~92%@105A	3P400 ~92.7%@750V, 3P400 ~92%@126A
Output				
Voltage Range		0~750V		
Current Range		0~84A	0~105A	0~126A
Power Range		0~24000W	0~30000W	0~36000W
Max. Setup Range	Voltage	0~787.5V(0~105%)		
	Current	0~85.68A(0~102%)	0~107.1A(0~102%)	0~128.52A(0~102%)
	Power	0~24600W(0~102.5%)	0~30750W(0~102.5%)	0~36900W(0~102.5%)
	Internal Resistance	0~268Ω	0~215Ω	0~179Ω
Accuracy	Voltage	<0.1% Umax(750mV)		
	Current	<0.2% I _{max} (168mA)	<0.2% I _{max} (210mA)	<0.2% I _{max} (252mA)
	Power	<1%+180W	<1%+240W	<1%+360W
	Internal Resistance	R<2% R _{max} , I<0.3% I _{max}		
Line Regulation	Voltage	<0.02% Umax(150mV)		
	Current	<0.05% I _{max} (42mA)	<0.05% I _{max} (52.5mA)	<0.05% I _{max} (63mA)
	Power	<0.05% P _{max}		
Load Regulation ^[2]	Voltage	<0.05% Umax(375mV) @Rated Voltage, <0.1% Umax(750mV) @Rated Current		
	Current	<0.15% I _{max} (126mA)	<0.15% I _{max} (157.5mA)	<0.15% I _{max} (189mA)
	Power	<0.75%P _{max}		
Rise Time	Voltage	<15ms (No Load) <80ms (Full Load)		
Drop Time	Voltage	<600ms (No Load) <20ms (Full Load)		
Transient Response Time ^[3]	Voltage	≤2ms/7.5V		
Display Resolution	Voltage	0.01V		
	Current	0.001A		
	Power	1W		
	Internal Resistance	0.001Ω		
Measurement Accuracy	Voltage	<0.1% Umax(750mV)		
	Current	<0.2% I _{max} (168mA)	<0.2% I _{max} (210mA)	<0.2% I _{max} (252mA)
	Power	<0.5% P _{max}		
	Internal Resistance	<0.4% R _{max}		
Ripple ^[4]	Voltage	<1000mVpp, <250mVrms		
	Current	<44mArms	<55mArms	<66mArms
Remote Compensation	Voltage	3% Umax(22.5V)		
Sink Function				
Input Voltage		0~750V		
Input Current		0~35A	0~40A	0~45A
Input Power		0~1200W	0~1500W	0~1800W
Min. Operating Voltage		5V@35A	5V@40A	5V@45A
CC Resolution		4mA	5mA	6mA

SP-3U/6U Series Wide-range High-power Programmable DC Power Supply

MODEL	SP750VDC24000W	SP750VDC30000W	SP750VDC36000W
CC Accuracy	<0.2% I _{max} (70mA)	<0.2% I _{max} (80mA)	<0.2% I _{max} (90mA)
CV Resolution	<4mV		
CV Accuracy	<0.1% U _{max} (750mV)		
CP Resolution	2W	2.5W	3W
CP Accuracy	<0.5% P _{max} (6000mW)	<0.5% P _{max} (7500mW)	<0.5% P _{max} (9000mW)
Slew Rate	0.01~2.5A/us		
Dynamic Mode	20ms~50s		
General			
Graphic Display	4.3" Color touch LCD		
Operation Key Feature	Soft keys, Numeric keys, Rotary knob, USB port for transfer and upgrading firmware		
Rack Mount Handles	Yes		
FAN	Temperature control		
Protection	OCP, OVP, OPP, OTP, HARD FAIL		
Interface	RS232/RS485/USB(Standard), GPIB/LAN(Optional), CAN(Optional)		
Command Response Time	<3ms		
Analog Interface(Optional)			
Set Value Inputs	Analog input 0~5V/0~10V or 0~5kΩ/0~10kΩ to set 0~105% voltage, current and power		
Actual Value Output	Analog output 0~5V/0~10V to monitor the voltage and current.		
Accuracy U/I/P/R	<0.2% F.S		
Actual Output U/I	<0.2%		
Control Signals	DC ON/OFF, External control Enable/Disable		
Status Signals	CV, OVP, OT		
Sampling Rate of Input & Output	45Hz		
Galvanic Isolation to the Device	4242VDC		
Master/Slave Control			
Series Output	MAX 2 units		
Parallel Output	MAX 16 units		
Environmental			
Operating Temperature	0~40°C		
Storage Temperature	-20~70°C		
Temperature Coefficient	100ppm/°C(voltage), 150ppm/°C(current)		
Relative Humidity	<95%RH(non-condensing)@35°C, <80%RH(non-condensing)@40°C		
Altitude	<2000m@40°C		
Fan Noise	48dB Idle; 77dB Max;	48dB Idle; 80dB Max;	48dB Idle; 82dB Max;
Mechanical			
Dimensions(WxHxD)	423.0x265.0x745.0 mm		
Package Dimensions(WxHxD)	549.0x531.0x946.0 mm		
Unit Weight	75kg	86kg	97kg
Shipping Weight	101kg	112kg	123kg
Miscellaneous			
Over Voltage Category	II		
Protection Class	I		
Pollution Degree	2		
Insulation	AC input <->DC output, 4242VDC, AC input <-> PE, 2818VDC		

[1] For different input voltage standard option must be specified at the time of order as they are installed at the factory prior to shipment.

[2] Load transient from 0% to 100% of rated output.

[3] Test value at 100% voltage and 100% power.

[4] V_{rms} @ 300kHz, V_{pp} @ 20MHz, A_{rms} @ 300kHz.

SP-3U/6U Series Wide-range High-power Programmable DC Power Supply

MODEL	SP1000VDC12000W	SP1000VDC24000W	SP1000VDC36000W
Input			
Voltage ^[1]	187~305VAC 340~480VAC	196~305VAC 340~480VAC	196~305VAC 340~480VAC
Current ^[1]	3P208 L1-60A, L2,L3-38A 3P400 L1-30A, L2,L3-19A	3P208 L3-60A, L1,L2-103A 3P400 L3-30A, L1,L2-49A	3P208 L1, L2,L3-103A 3P400 L1, L2,L3-63A
Frequency	45-65Hz		
Connection	3ph, PE		
Fuse (Internal) ^[1]	T50A*2pcs T30A*2pcs		
Power Factor	>0.99		
Input Power	3P208 13.8kVAmax, 3P400 13.4KVAmax	3P208 27.6kVAmax, 3P400 26.8KVAmax	3P208 40.2kVAmax, 3P400 39.0KVAmax
Efficiency ^[1]	3P208 ~92%@1000V, 3P208 ~90%@32A 3P400 ~93.5%@1000V, 3P400 ~92%@32A	3P208 ~92%@1000V, 3P208 ~90%@64A 3P400 ~93.5%@1000V, 3P400 ~92%@64A	3P208 ~92%@1000V, 3P208 ~90%@96A 3P400 ~93.5%@1000V, 3P400 ~92%@96A
Output			
Voltage Range	0~1000V		
Current Range	0~32A	0~64A	0~96A
Power Range	0~12000W	0~24000W	0~36000W
Max. Setup Range	Voltage	0~1050V(0~105%)	
	Current	0~33.6A(0~105%)	0~65.28A(0~102%)
	Power	0~12300W(0~102.5%)	0~24600W(0~102.5%)
	Internal Resistance	0~937.5Ω	0~468.75Ω
Accuracy	Voltage	<0.1% Umax(1000mV)	
	Current	<0.2% Imax(64mA)	<0.2% Imax(128mA)
	Power	<1%+90W	<1%+180W
	Internal Resistance	R<2% Rmax, I<0.3% Imax	
Line Regulation	Voltage	<0.02% Umax(200mV)	
	Current	<0.05% Imax(16mA)	<0.05% Imax(32mA)
	Power	<0.05% Pmax	
Load Regulation ^[2]	Voltage	<0.05% Umax(500mV) @Rated Voltage, <0.08% Umax(800mV) @Rated Current	
	Current	<0.15% Imax(48mA)	<0.15% Imax(96mA)
	Power	<0.75%Pmax	
Rise Time	Voltage	<15ms (No Load) <85ms (Full Load)	<15ms (No Load) <85ms (Full Load)
Drop Time	Voltage	<1700ms (No Load) <15ms (Full Load)	
Transient Response Time ^[3]	Voltage	≤2ms/10V	≤1.5ms/5V
Display Resolution	Voltage	0.01V	
	Current	0.001A	
	Power	1W	
	Internal Resistance	0.001Ω	
Measurement Accuracy	Voltage	<0.1% Umax(1V)	
	Current	<0.2% Imax(64mA)	<0.2% Imax(128mA)
	Power	<0.5% Pmax	
	Internal Resistance	<0.4% Rmax	
Ripple ^[4]	Voltage	<1500mVpp, <320mVrms	
	Current	<22mArms	<48mArms
Remote Compensation	Voltage	3% Umax(30V)	
General			
Graphic Display	4.3" Color touch LCD		
Operation Key Feature	Soft keys, Numeric keys, Rotary knob, USB port for transfer and upgrading firmware		
Rack Mount Handles	Yes		
FAN	Temperature control		
Protection	OCP, OVP, OPP, OTP, HARD FAIL		

SP-3U/6U Series Wide-range High-power Programmable DC Power Supply

MODEL	SP1000VDC12000W	SP1000VDC24000W	SP1000VDC36000W
Interface	RS232/RS485/USB(Standard), GPIB/LAN(Optional), CAN(Optional)		
Command Response Time	<3ms		
Analog Interface(Optional)			
Set Value Inputs	Analog input 0~5V/0~10V or 0~5kΩ/0~10kΩ to set 0~105% voltage, current and power		
Actual Value Output	Analog output 0~5V/0~10V to monitor the voltage and current.		
Accuracy U/I/P/R	<0.2% F.S		
Actual Output U/I	<0.2%		
Control Signals	DC ON/OFF, External control Enable/Disable		
Status Signals	CV, OVP, OT		
Sampling Rate of Input & Output	45Hz		
Galvanic Isolation to the Device	4242VDC		
Master/Slave Control			
Series Output	Not supported		
Parallel Output	MAX 16 units		
Environmental			
Operating Temperature	0~40°C		
Storage Temperature	-20~70°C		
Temperature Coefficient	100ppm/°C(voltage), 150ppm/°C(current)		
Relative Humidity	<95%RH(non-condensing)@35°C, <80%RH(non-condensing)@40°C		
Altitude	<2000m@40°C		
Fan Noise	45dB Idle; 73dB Max;	48dB Idle; 80dB Max;	48dB Idle; 82dB Max;
Mechanical			
Dimensions(WxHxD)	423.0x133.0x718.0 mm	423.0x265.0x745.0 mm	423.0x265.0x745.0 mm
Package Dimensions(WxHxD)	665.0x347.0x1009.0 mm	549.0x531.0x946.0 mm	549.0x531.0x946.0 mm
Unit Weight	38kg	75kg	97kg
Shipping Weight	48kg	101kg	123kg
Miscellaneous			
Over Voltage Category	II		
Protection Class	I		
Pollution Degree	2		
Insulation	AC input <->DC output, 4242VDC, AC input <-> PE, 2818VDC		

[1] For different input voltage standard option must be specified at the time of order as they are installed at the factory prior to shipment.

[2] Load transient from 0% to 100% of rated output.

[3] Test value at 100% voltage and 100% power.

[4] Vrms @ 300kHz, Vpp @ 20MHz, Arms @ 300kHz.

SP-3U/6U Series Wide-range High-power Programmable DC Power Supply

MODEL		SP1500VDC12000W	SP1500VDC18000W
Input			
Voltage ^[1]		187~305VAC 340~480VAC	
Current ^[1]		3P208 L1-60A, L2,L3-38A 3P400 L1-30A, L2,L3-19A	3P208 L1,L2,L3-60A 3P400 L1,L2,L3-30A
Frequency		45-65Hz	
Connection		3ph, PE	
Fuse (Internal) ^[1]		T50A*2pcs T25A*2pcs	T30A*2pcs
Power Factor		>0.99	
Input Power		3P208 13.8KVAmx, 3P400 13.4KVAmx	3P208 20.5KVAmx, 3P400 19.9KVAmx
Efficiency ^[1]		3P208 ~92%@1500V, 3P208 ~90.5%@21A 3P400 ~92.5%@1500V, 3P400 ~91.5%@21A	3P208 ~92%@1500V, 3P208 ~90%@32A 3P400 ~93.5%@1500V, 3P400 ~92%@32A
Output			
Voltage Range		0~1500V	
Current Range		0~21A	0~32A
Power Range		0~12000W	0~18000W
Max. Setup Range	Voltage	0~1575V(0~105%)	
	Current	0~22.05A(0~105%)	0~33.6A(0~105%)
	Power	0~12300W(0~102.5%)	0~18450W(0~102.5%)
	Internal Resistance	0~2142Ω	0~1406.3Ω
Accuracy	Voltage	<0.1% Umax(1.5V)	
	Current	<0.2% Imax(42mA)	<0.2% Imax(64mA)
	Power	<1%+90W	<0.5%+90W
	Internal Resistance	R<2% Rmax, I<0.3% Imax	
Line Regulation	Voltage	<0.02% Umax(300mV)	
	Current	<0.05% Imax(10.5mA)	<0.05% Imax(16mA)
	Power	<0.05% Pmax	
Load Regulation ^[2]	Voltage	<0.05% Umax(750mV) @Rated Voltage, <0.08% Umax(1200mV) @Rated Current	
	Current	<0.15% Imax(31.5mA)	<0.15%Imax(48mA)
	Power	<0.75% Pmax	
Rise Time	Voltage	<15ms (No Load) <80ms (Full Load)	<15ms (No Load) <90ms (Full Load)
Drop Time	Voltage	<700ms (No Load) <20ms (Full Load)	<1800ms (No Load) <15ms (Full Load)
Transient Response Time ^[3]	Voltage	≤2ms/15V	
Display Resolution	Voltage	0.01V	
	Current	0.001A	
	Power	1W	0.1W
	Internal Resistance	0.001Ω	
Measurement Accuracy	Voltage	<0.1% Umax(1.5V)	
	Current	<0.2% Imax(42mA)	<0.2% Imax(64mA)
	Power	<0.5% Pmax	
	Internal Resistance	<0.4% Rmax	
Ripple ^[4]	Voltage	<2500mVpp, <600mVrms	<1950mVpp, <650mVrms
	Current	<11mArms	<22mArms
Remote Compensation	Voltage	3% Umax(45V)	
General			
Graphic Display		4.3" Color touch LCD	
Operation Key Feature		Soft keys, Numeric keys, Rotary knob, USB port for transfer and upgrading firmware	
Rack Mount Handles		Yes	
FAN		Temperature control	
Protection		OCP, OVP, OPP, OTP, HARD FAIL	

SP-3U/6U Series Wide-range High-power Programmable DC Power Supply

MODEL	SP1500VDC12000W	SP1500VDC18000W
Interface	RS232/RS485/USB(Standard), GPIB/LAN(Optional), CAN(Optional)	
Command Response Time	<3ms	
Analog Interface(Optional)		
Set Value Inputs	Analog input 0~5V/0~10V or 0~5kΩ/0~10kΩ to set 0~105% voltage, current and power	
Actual Value Output	Analog output 0~5V/0~10V to monitor the voltage and current.	
Accuracy U/I/P/R	<0.2% F.S	
Actual Output U/I	<0.2%	
Control Signals	DC ON/OFF, External control Enable/Disable	
Status Signals	CV, OVP, OT	
Sampling Rate of Input & Output	45Hz	
Galvanic Isolation to the Device	5250VDC	
Master/Slave Control		
Series Output	MAX 2 units	
Parallel Output	MAX 16 units	
Environmental		
Operating Temperature	0~40°C	
Storage Temperature	-20~70°C	
Temperature Coefficient	100ppm/°C(voltage), 150ppm/°C(current)	
Relative Humidity	<95%RH(non-condensing)@35°C, <80%RH(non-condensing)@40°C	
Altitude	<2000m@40°C	
Fan Noise	45dB Idle; 73dB Max;	45dB Idle; 75dB Max;
Mechanical		
Dimensions(WxHxD)	423.0x133.0x718.0 mm	
Package Dimensions(WxHxD)	665.0x347.0x1009.0 mm	
Unit Weight	38kg	50kg
Shipping Weight	48kg	60kg
Miscellaneous		
Over Voltage Category	II	
Protection Class	I	
Pollution Degree	2	
Insulation	AC input <->DC output, 5040VDC, AC input <-> PE, 2818VDC	

[1] For different input voltage standard option must be specified at the time of order as they are installed at the factory prior to shipment.

[2] Load transient from 0% to 100% of rated output.

[3] Test value at 100% voltage and 100% power.

[4] Vrms @ 300kHz, Vpp @ 20MHz, Arms @ 300kHz.

SP-3U/6U Series Wide-range High-power Programmable DC Power Supply

MODEL	SP1500VDC24000W		SP1500VDC36000W	
Input				
Voltage ^[1]	196~305VAC		340~480VAC	
Current ^[1]	3P208 L1-60A, L2,L3-103A		3P208 L1,L2,L3-125A	
	3P400 L1-30A, L2,L3-49A		3P400 L1,L2,L3-63A	
Frequency	45-65Hz			
Connection	3ph, PE			
Fuse (Internal) ^[1]	T50A*2pcs			
	T25A*2pcs			
Power Factor	>0.99			
Input Power	3P208 27.6KVAmx, 3P400 26.8KVAmx		3P208 40.2KVAmx, 3P400 39.0KVAmx	
Efficiency ^[1]	3P208 ~92%@1500V, 3P208 ~90.5%@42A		3P208 ~92%@1500V, 3P208 ~90.5%@63A	
	3P400 ~92.5%@1500V, 3P400 ~91.5%@42A		3P400 ~92.5%@1500V, 3P400 ~91.5%@63A	
Output				
Voltage Range	0~1500V			
Current Range	0~42A		0~63A	
Power Range	0~24000W		0~36000W	
Max. Setup Range	Voltage	0~1575V(0~105%)		
	Current	0~42.84A(0~102%)		0~64.26A(0~102%)
	Power	0~24600W(0-102.5%)		0~36900W(0-102.5%)
	Internal Resistance	0~1071Ω		0~714Ω
Accuracy	Voltage	<0.1% Umax(1.5V)		
	Current	<0.2% I _{max} (84mA)		<0.2% I _{max} (126mA)
	Power	<1%+180W		<1%+360W
	Internal Resistance	R<2% R _{max} , I<0.3% I _{max}		
Line Regulation	Voltage	<0.02% Umax(300mV)		
	Current	<0.05% I _{max} (21mA)		<0.05% I _{max} (31.5mA)
	Power	<0.05% P _{max}		
Load Regulation ^[2]	Voltage	<0.05% Umax(750mV) @Rated Voltage, <0.08% Umax(1200mV) @Rated Current		
	Current	<0.15% I _{max} (63mA)		<0.15% I _{max} (94.5mA)
	Power	<0.75% P _{max}		
Rise Time	Voltage	<15ms (No Load) <80ms (Full Load)		
Drop Time	Voltage	<700ms (No Load) <20ms (Full Load)		
Transient Response Time ^[3]	Voltage	≤2ms/15V		
Display Resolution	Voltage	0.01V		
	Current	0.001A		
	Power	1W		
	Internal Resistance	0.001Ω		
Measurement Accuracy	Voltage	<0.1% Umax(1.5V)		
	Current	<0.2% I _{max} (84mA)		<0.2% I _{max} (126mA)
	Power	<0.5% P _{max}		
	Internal Resistance	<0.4% R _{max}		
Ripple ^[4]	Voltage	<2500mVpp, <600mVrms		
	Current	<22mArms		<33mArms
Remote Compensation	Voltage	3% Umax(45V)		
General				
Graphic Display	4.3" Color touch LCD			
Operation Key Feature	Soft keys, Numeric keys, Rotary knob, USB port for transfer and upgrading firmware			
Rack Mount Handles	Yes			
FAN	Temperature control			
Protection	OCP, OVP, OPP, OTP, HARD FAIL			

SP-3U/6U Series Wide-range High-power Programmable DC Power Supply

MODEL	SP1500VDC24000W	SP1500VDC36000W
Interface	RS232/RS485/USB(Standard), GPIB/LAN(Optional), CAN(Optional)	
Command Response Time	<3ms	
Analog Interface(Optional)		
Set Value Inputs	Analog input 0~5V/0~10V or 0~5kΩ/0~10kΩ to set 0~105% voltage, current and power	
Actual Value Output	Analog output 0~5V/0~10V to monitor the voltage and current.	
Accuracy U/I/P/R	<0.2% F.S	
Actual Output U/I	<0.2%	
Control Signals	DC ON/OFF, External control Enable/Disable	
Status Signals	CV, OVP, OT	
Sampling Rate of Input & Output	45Hz	
Galvanic Isolation to the Device	5250VDC	
Master/Slave Control		
Series Output	Not supported	
Parallel Output	MAX 16 units	
Environmental		
Operating Temperature	0~40°C	
Storage Temperature	-20~70°C	
Temperature Coefficient	100ppm/°C(voltage), 150ppm/°C(current)	
Relative Humidity	<95%RH(non-condensing)@35°C, <80%RH(non-condensing)@40°C	
Altitude	<2000m@40°C	
Fan Noise	48dB Idle; 80dB Max;	48dB Idle; 82dB Max;
Mechanical		
Dimensions(WxHxD)	423.0x265.0x745.0 mm	
Package Dimensions(WxHxD)	549.0x531.0x946.0 mm	
Unit Weight	75kg	97kg
Shipping Weight	101kg	123kg
Miscellaneous		
Over Voltage Category	II	
Protection Class	I	
Pollution Degree	2	
Insulation	AC input <->DC output, 5040VDC, AC input <-> PE, 2818VDC	

[1] For different input voltage standard option must be specified at the time of order as they are installed at the factory prior to shipment.

[2] Load transient from 0% to 100% of rated output.

[3] Test value at 100% voltage and 100% power.

[4] Vrms @ 300kHz, Vpp @ 20MHz, Arms @ 300kHz.

SP-3U/6U Series Wide-range High-power Programmable DC Power Supply

MODEL		SP2250VDC18000W
Input		
Voltage ^[1]		187~305VAC 340~480VAC
Current ^[1]		3P208 L1,L2,L3-60A 3P400 L1,L2,L3-30A
Frequency		45-65Hz
Connection		3ph, PE
Fuse (Internal) ^[1]		T50A*2pcs T25A*2pcs
Power Factor		>0.99
Input Power		3P208 20.1KVAmx, 3P400 19.5KVAmx
Efficiency ^[1]		3P208 ~92%@2250V, 3P208 ~90.5%@21A 3P400 ~92.5%@2250V, 3P400 ~91.5%@21A
Output		
Voltage Range		2250V
Current Range		0~21A
Power Range		0~18000W
Max. Setup Range	Voltage	0~2362.5V(0-105%)
	Current	0~22.05A(0-105%)
	Power	0~18450W(0~102.5%)
	Internal Resistance	0~3214Ω
Accuracy	Voltage	<0.1% Umax/(2.25V)
	Current	<0.2% Imax(42mA)
	Power	<0.5%+90W
	Internal Resistance	R<2% Rmax, I<0.3% Imax
Line Regulation	Voltage	<0.02% Umax(675mV)
	Current	<0.05% Imax(10.5mA)
	Power	<0.05% Pmax
Load Regulation ^[2]	Voltage	<0.05% Umax(1125mV) @Rated Voltage, <0.08% Umax(1800mV) @Rated Current
	Current	<0.15% Imax(31.5mA)
	Power	<0.75% Pmax
Rise Time	Voltage	<15ms (No Load) <85ms (Full Load)
Drop Time	Voltage	<800ms (No Load) <20ms (Full Load)
Transient Response Time ^[3]	Voltage	≤3ms/22.5V
Display Resolution	Voltage	0.01V
	Current	0.001A
	Power	0.1W
	Internal Resistance	0.001Ω
Measurement Accuracy	Voltage	<0.1% Umax(2.25V)
	Current	<0.2% Imax(42mA)
	Power	<0.5% Pmax
	Internal Resistance	<0.4% Rmax
Ripple ^[4]	Voltage	<3200mVpp, <750mVrms
	Current	<11mArms
Remote Compensation	Voltage	3% Umax(67.5V)
General		
Graphic Display		4.3" Color touch LCD
Operation Key Feature		Soft keys, Numeric keys, Rotary knob, USB port for transfer and upgrading firmware
Rack Mount Handles		Yes
FAN		Temperature control
Protection		OCP, OVP, OPP, OTP, HARD FAIL

SP-3U/6U Series Wide-range High-power Programmable DC Power Supply

MODEL	SP2250VDC18000W
Interface	RS232/RS485/USB(Standard), GPIB/LAN(Optional), CAN(Optional)
Command Response Time	<3ms
Set Value Inputs	
Set Value Inputs	Analog input 0~5V/0~10V or 0~5kΩ/0~10kΩ to set 0~105% voltage, current and power
Actual Value Output	Analog output 0~5V/0~10V to monitor the voltage and current.
Accuracy U/I/P/R	<0.2% F.S
Actual Output U/I	<0.2%
Control Signals	DC ON/OFF, External control Enable/Disable
Status Signals	CV, OVP, OT
Sampling Rate of Input & Output	45Hz
Galvanic Isolation to the Device	6300VDC
Master/Slave Control	
Series Output	Not supported
Parallel Output	MAX 16 units
Environmental	
Operating Temperature	0~40°C
Storage Temperature	-20~70°C
Temperature Coefficient	100ppm/°C(voltage), 150ppm/°C(current)
Relative Humidity	<95%RH(non-condensing)@35°C, <80%RH(non-condensing)@40°C
Altitude	<2000m@40°C
Fan Noise	45dB Idle; 75dB Max;
Mechanical	
Dimensions(WxHxD)	423.0x133.0x718.0 mm
Package Dimensions(WxHxD)	665.0x347.0x1009.0 mm
Unit Weight	50kg
Shipping Weight	60kg
Miscellaneous	
Over Voltage Category	II
Protection Class	I
Pollution Degree	2
Insulation	AC input <->DC output, 5040VDC, AC input <-> PE, 2818VDC

[1] For different input voltage standard option must be specified at the time of order as they are installed at the factory prior to shipment.

[2] Load transient from 0% to 100% of rated output.

[3] Test value at 100% voltage and 100% power.

[4] Vrms @ 300kHz, Vpp @ 20MHz, Arms @ 300kHz.

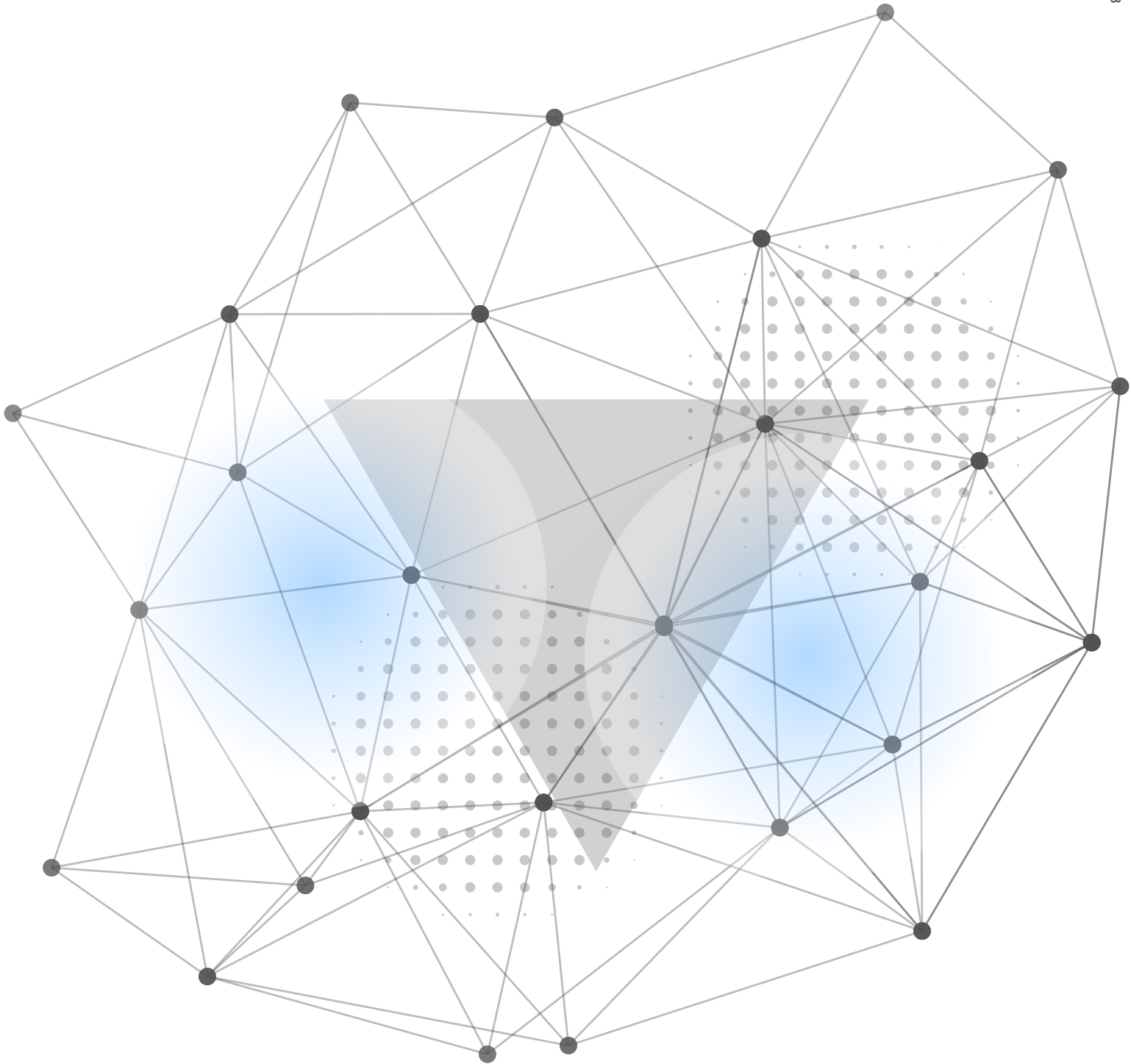

APM Technologies Ltd

Add: #7, Link Industry Park, Kechuang Road, Nancheng,
Dongguan, Guangdong, China
Tel: +86 769-8698 9800 ext:8901
E-mail: overseas@apmtech.cn

Web: www.apmtechate.com



Scan the QR code for more information